

ecoHaus

HIGH PERFORMANCE GLAZING

Location: Surrey

Type: Newbuild

Architect: Nick Wilson Architects:

Products: Internorm & Visiline



ecoHaus specialises in the Supply & Installation of Windows & Doors into Newbuild, Large Remodelling & Extension Projects across the UK.

ecoHaus only work with the best products on the market and for the past 10 years, ecoHaus has been the largest Internorm Partner in the UK offering the full range of Internorm products to its clients. In 2018 ecoHaus launched its own brand of Aluminium Windows and doors, Visiline and in 2022 ecoHaus became official partners of Rationel & Velfac so we can offer our clients a full breadth of product to suit any project.

ecoHaus has an exceptional reputation for providing a complete service from Sales through to Installation taking complete ownership of the process and providing its clients with peace of mind when purchasing their windows for their project.

Official Partners of:

VELFAC[®]

Internorm

rationel[®]

Visi|line



Google Reviews

4.7 ★★★★★

Location: Kent

Type: Newbuild

Architect: Undisclosed

Products: Internorm



Visi|line

Premium range of Slimline Aluminium Windows &
Doors:

ALU5 Window
ALU5 View Window
Visiline 1 Sliding Door
Visiline 2 Sliding Door
Visiline 3 Sliding Door
Bifold Door

ALU5 Aluminium Window



Properties:

- Tilt & Turn Window
- Casement Open Out
- 70mm Frame Depth
- 88mm Sightline inc Opener
- Triple Glazed Option
- Insulated Frame
- Triple Gasket System
- U-Value 1.03Wm²k Triple Glazed

ALU5 VIEW Hidden Sash Aluminium Window



Properties:

- Tilt & Turn Window
- 70mm Frame Depth
- 66mm Sightline inc Opener
- Triple Glazed Option
- Insulated Frame
- Triple Gasket System
- U-Value 1.00Wm²k Triple Glazed

ALU5 Window Casement

The ALU5 Window is available as an open out casement style as well as a Tilt & Turn

Double Glazed as standard the ALU Window can achieve U-Values as low as 1.35Wm²K.



ALU5 VIEW Window

Setting the standard in Slimline Aluminium windows, the ALU5 View Window has a hidden sash ensuring equal sightlines for fixed and opening windows with a visible sightline of only 66mm.

Double Glazed as standard the ALU5 VIEW Windows can achieve U-Values as low as 1.32Wm²K.



Visiline Windows in Detail



Visiline Window Handles

The Visiline Windows come with a range of handle options to provide our clients with a variety of choice to suit any project type.

All Handles are available in: Silver, Black, White or Anthracite Grey

Types of handles available for Aluminium windows:



Cortizo (standard)



Polaris



Cortizo (minimalist)



Polaris inc Key



Arch "invisible"

For systems **ALU5 View** and **ALU6 View**, in addition to the hidden sash, there is also the possibility to choose an "invisible" handle. This type of handle is embedded in the side of the frame, giving a minimalist look to the whole system.

Aluminium | Visi|line 2 | Double Glazed Slimline Sliding Door

- Central interlock size (meeting point of the sash): 20mm
- Assembly depth: two-rail frame - 116mm; three-rail frame - 182mm
- Thermal insulation coefficient $U_w \geq 1.4 \text{ W/m}^2\text{K}^*$
- Modern and minimalist design
- Maximum Panel Width 2200mm
- Maximum Panel Height 3000mm
- Special Features inc; Moving Corners / Pocket Doors
- Optional Integral ACO Drain



Aluminium | Visiline 3 | Triple Glazed Slimline Sliding Door

- Central interlock size (meeting point of the sash): 25mm;
- Assembly depth: two-rail frame - 180mm; three-rail frame - 278mm;
- Thermal insulation coefficient $U_w \geq 0.98 \text{ W/m}^2\text{K}^*$;
- Elegant and minimalist design;
- Large glazing;
- Weatherproof;
- Increased security;
- Special Features inc: Moving Corner, Pocket Door, Electric Operated door
- Maximum Width: 3000mm Maximum Height: 3600mm (subject to technical approval)



Opening Configurations

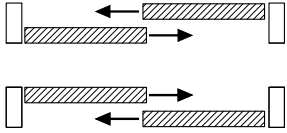
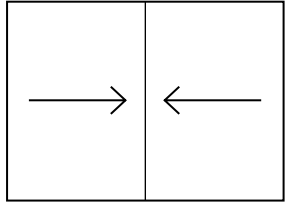

2 sashes

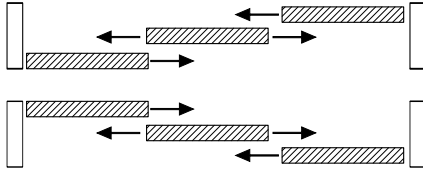
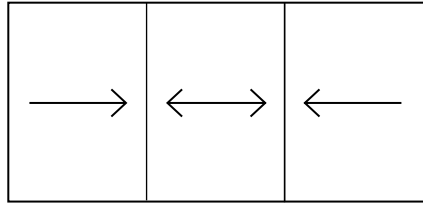

3 sashes - three-rail frame

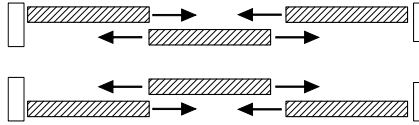
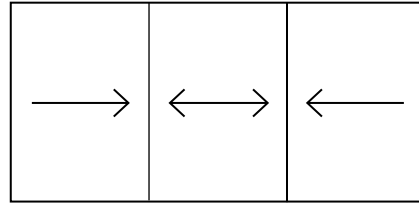

3 sashes - two-rail frame

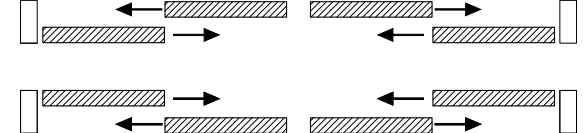
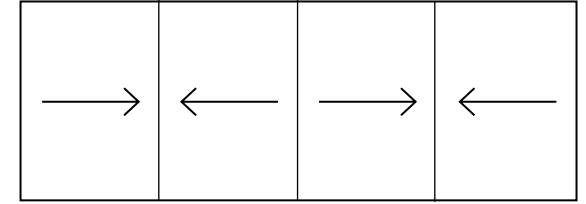

4 sashes

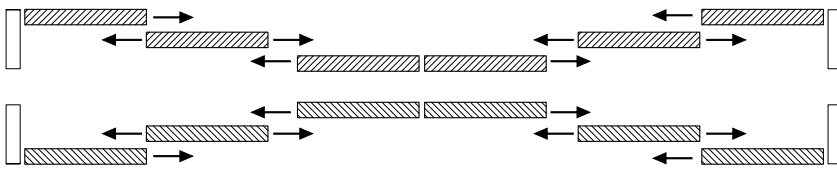
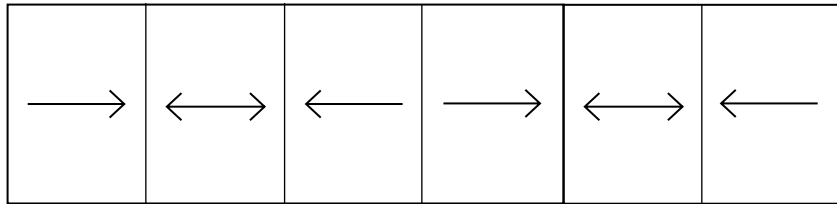

6 sashes

Opening Configurations

Manually operated - 6 sashes

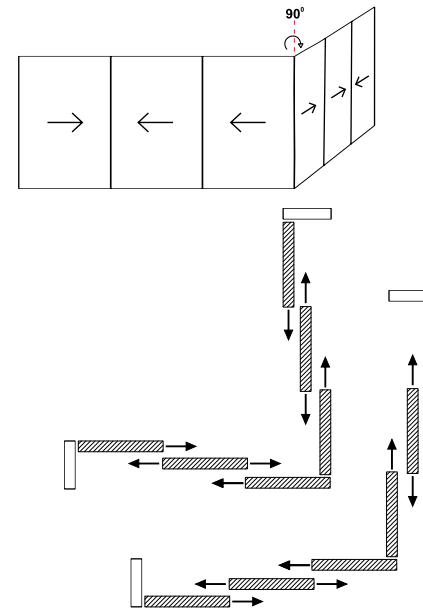
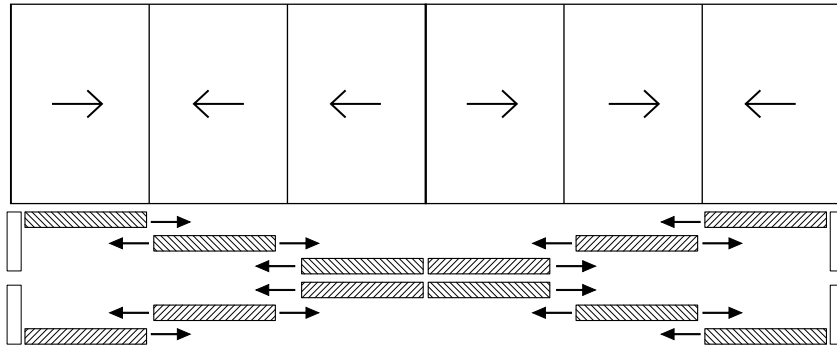

Pocket-sliding system - Manually operated

1 sash

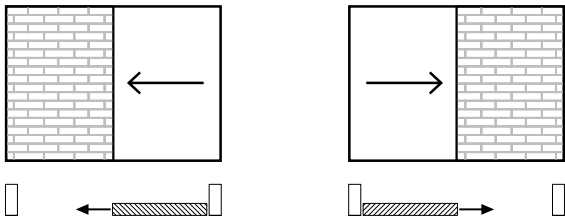

2 sashes - 2 rails

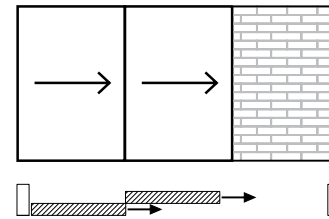
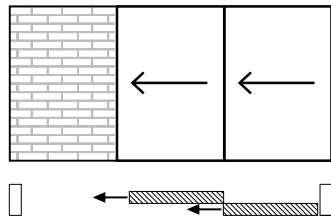

2 sashes - 1 rail

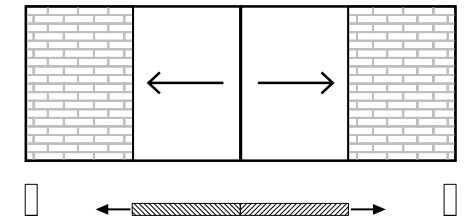

3 sashes

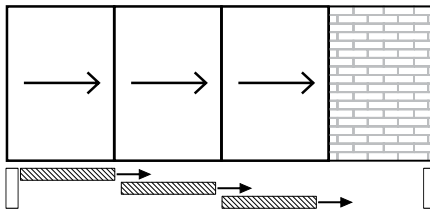
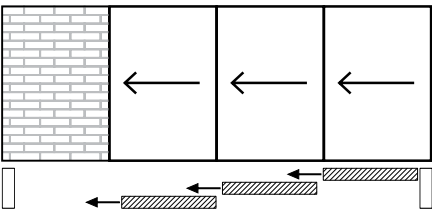

4 sashes

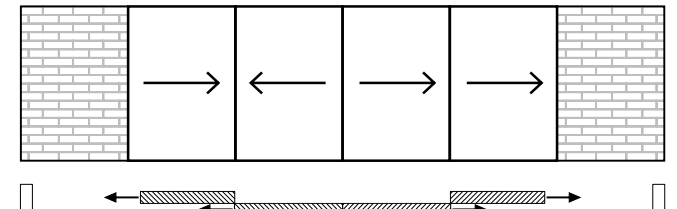

Sliding system | Aluminium | Visiline 1

- Central interlock size (meeting point of the sash): 35mm;
- Assembly depth:
 - two-rail frame - 70 mm;
 - three-rail frame - 126 mm;
- Exterior wall thickness of profiles: 2mm;
- Thermal insulation coefficient $U_w \geq 1.1 \text{ W/m}^2\text{K}$;
- Large glazed surface;
- Very easy handling.

* $U_w = 1.1 \text{ W/m}^2\text{K}$ value was obtained for a construction with L - 4282mm, H - 2240mm, two sashes and glazing with $U_g = 0.5 \text{ W/m}^2\text{K}$

System indicated for sashes with a maximum width of 2200mm and a maximum height of 2600mm.



Opening Configurations

2 sashes

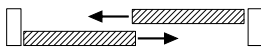
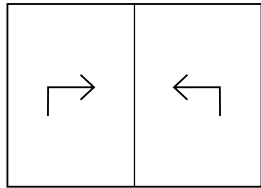

3 sashes

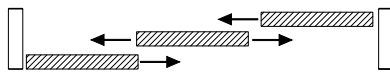
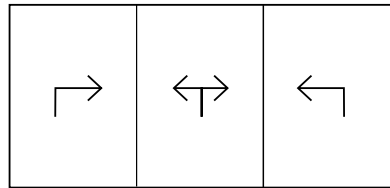

4 sashes

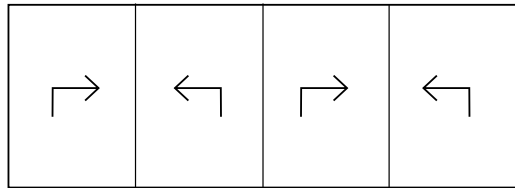

6 sashes

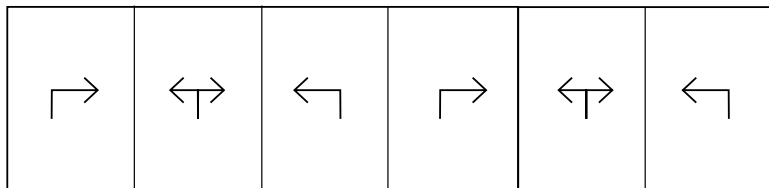

Folding system | Aluminium | BiFold

- Assembly depth: 73 mm;
- Exterior wall thickness of profiles: 1.8mm;
- Thermal insulation coefficient $U_w \geq 1.26 \text{ W/m}^2\text{K}^*$;
- Ideal way to connect indoor and outdoor spaces;
- Supports large constructions;
- Silent movement;
- No seasonal adjustments required;
- It can be accessorized with special ramps for people with disabilities.

* $U_w = 1.26 \text{ W/m}^2\text{K}$ value was obtained for a construction with L - 4282mm, H - 2240mm, five sashes and glazing with $U_g = 0.6 \text{ W/m}^2\text{K}$

System indicated for sashes with a maximum width of 1200mm and a maximum height of 2920mm.



Opening Configurations

Openings both inwards and outwards

2 sashes 2.2.0

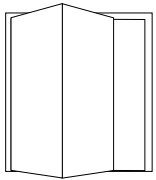

3 sashes 3.3.0

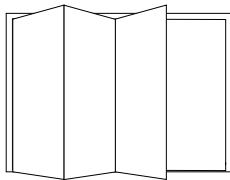

3 sashes 3.2.1

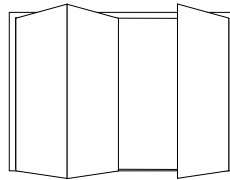

4 sashes 4.4.0

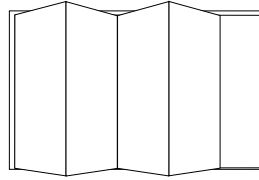

4 sashes 4.3.1

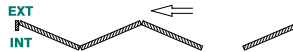
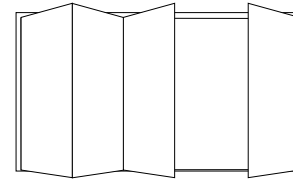

4 sashes 4.2.2

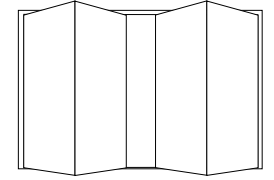

5 sashes 5.5.0

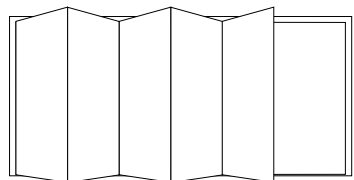

5 sashes 5.4.1

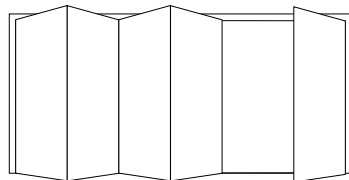

5 sashes 5.3.2

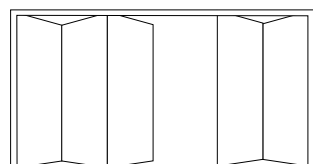
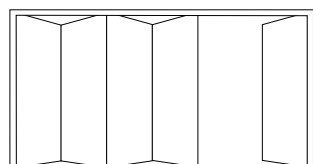
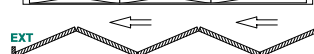
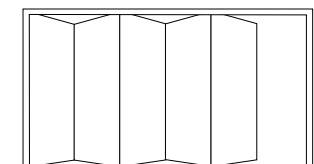
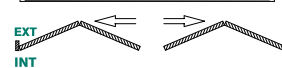
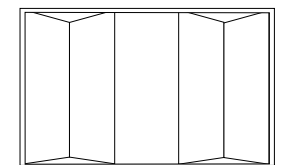
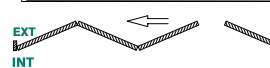
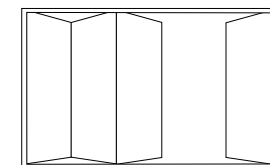
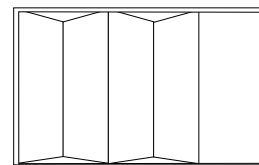
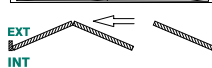
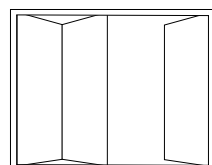
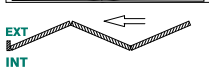
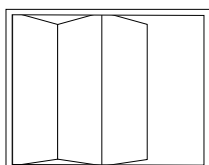
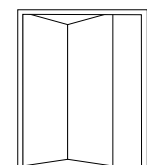
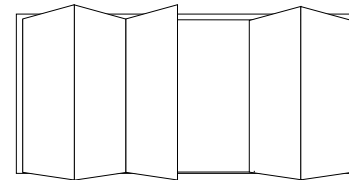

Location: Hertfordshire

Type: Passivhaus

Architect: Gresford Architects

Products: Internorm



Location: Scotland

Type: Newbuild

Architect: Brown & Brown Architects

Products: Internorm



Premium Entrance Doors

Door systems manufactured with aluminium profiles, heat barrier and additional insulation.

Two frames are available of 70 and 80 mm mount depths, respectively.

Characteristics

The PREMIUM series is equipped with 81 mm-thick aluminium panels and hidden inner/outer sash.

The glass packages used for skylights and small French doors contain three panes of glass of thickness 44 mm.

They are equipped as standard with 3D cylindrical hinges (3-axis adjustment), silver. Optionally anthracite grey, white or black. All system gaskets are black.

Ud Value: 0.9Wm2K

* The Ud value is calculated for a 1000 mm x 2300 mm door.

Minimum/maximum sash sizes

Minimum width 650 mm; maximum width 1250 mm

Minimum height 1850 mm; maximum height 2453 mm

Maximum permissible sash weight: 120 kg

Handles Options

Round Stainless Steel;
650 / 800 / 1400 / 1800mm



Square Stainless Steel or
Black Anodised;
650 / 800 / 1400 / 1800mm



NEW Square Stainless Steel
Handle with Finger Scanner'
550 / 750 / 1350 / 1750mm



Internal Handle available in;
Silver / Grey / Black / White



Electronic Entrance Systems inc;
KeyPad
Finger Scanner

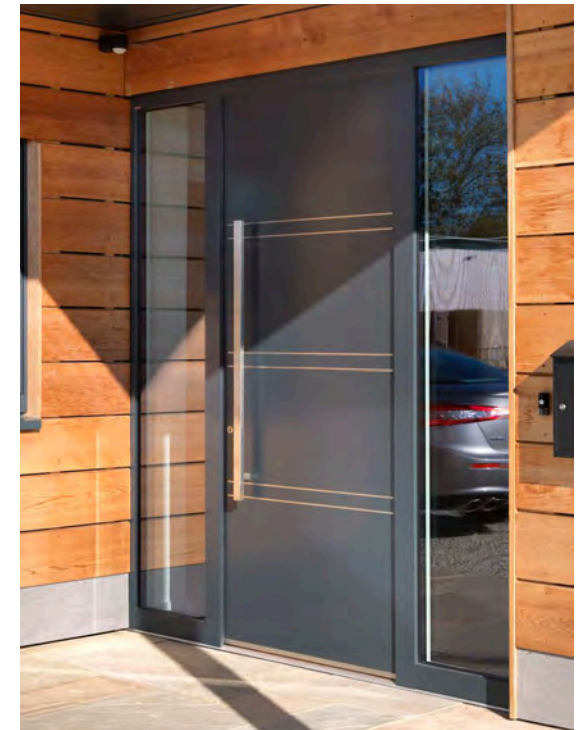

QF-AL-09



QF-AL-22

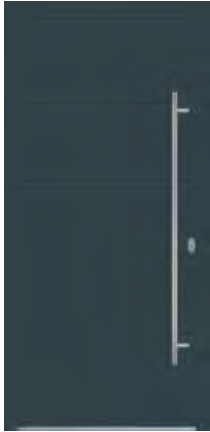

QF-AL-23



QF-AL-32



QF-AL-00



QF-AL-10



QF-AL-30



QF-AL-29



QF-AL-18



QF-AL-25



QF-AL-27



QF-AL-20



QF-AL-06



QF-AL-05

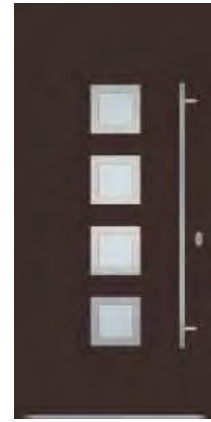

Simple door



Door with small french side door



Door with two small french doors



Simple door with fanlight



Door with small french side door and fanlight



Door with two small french doors and fanlight



Double wing door with faceplate

Visiline Colour Range

The Visiline Windows and Doors are available in a range of carefully selected RAL Colours to ensure we meet all of our clients requirements. To ensure the highest quality, all our Powder Coated finishes have a "structural" finish to enhance weather performance.

Group 1 Colours



Group 2 Colours

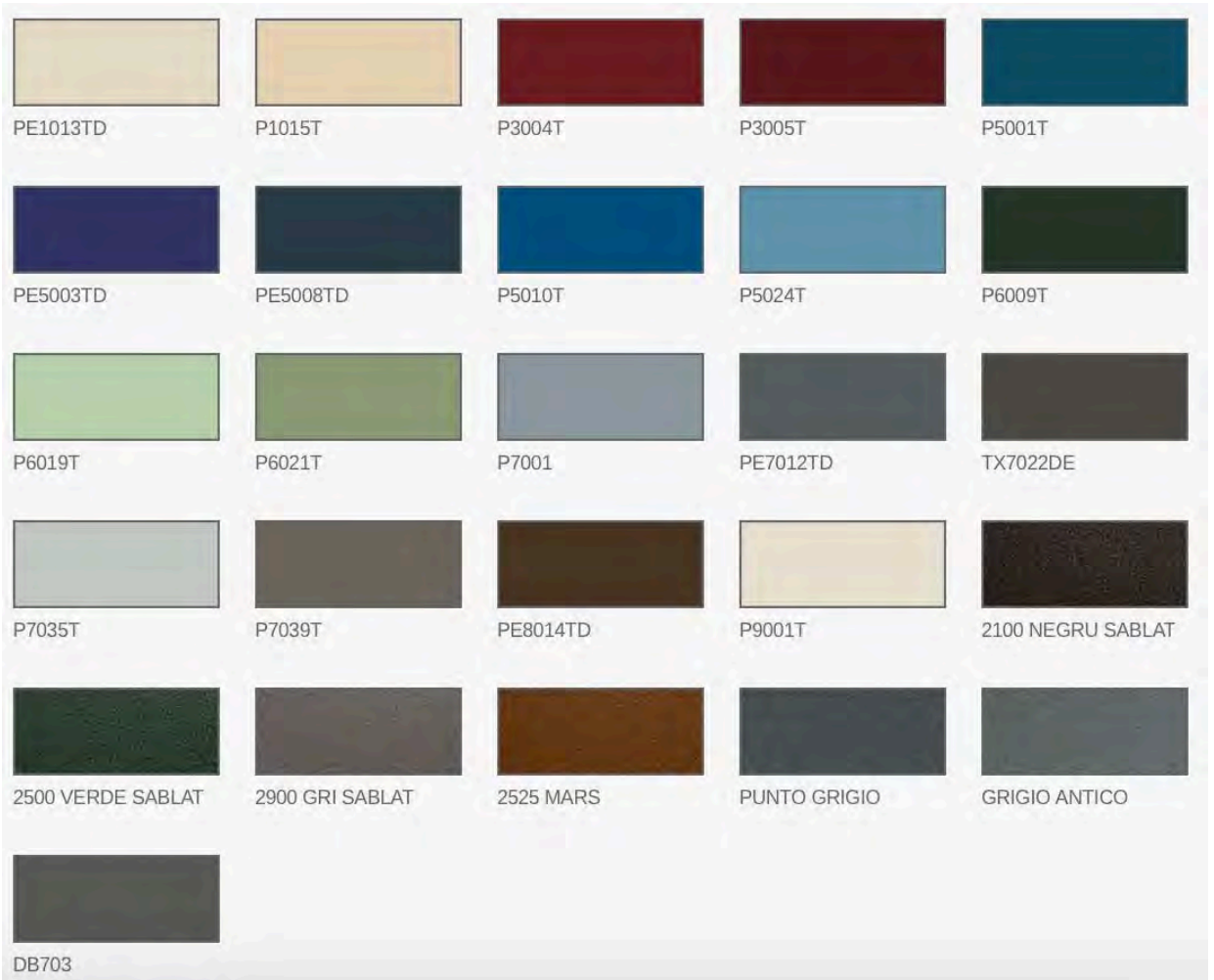

Location: Tenby

Type: Newbuild

Architect: OB Architecture

Products: Internorm & Visiline



Location: Gloucestershire

Type: Extension

Architect: Ford Architecture

Products: Internorm



Internorm®

High Performance Range of Triple Glazed
Composite Windows & Doors:

HF410 Timber Composite Window

HV450 Integrated Blind Window

KF410 Upvc/Alu Composite Window

KV440 Upvc/Alu Integrated Blind Window

HS330 & KS430 Lift & Slide Door

HT/AT Entrance Doors

HF410 Timber Composite Window



Properties:

- Tilt & Turn Window
- 85mm Frame Depth
- 108mm Sightline inc Opener
- Triple Glazed
- Foam Insulated Frame
- Triple Gasket System
- U-Value as low as 0.64Wm²k
- Passivhaus Certified
- Spruce | Oak | Ash | Larch | Walnut Internal finishes

studio

home pure

home soft

ambiente

Timber Range

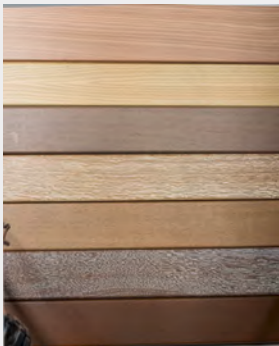

ITEC Core



Concealed Hardware



HV450 Timber Composite Window inc Integrated Blinds

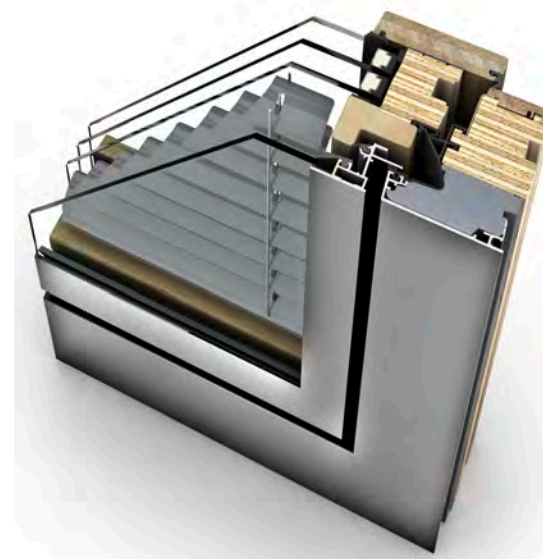

Properties:

- Tilt & Turn Window
- 85mm Frame Depth
- 108mm Sightline inc Opener
- 2+1 Glazing or 3+1 Glazing
- Foam Insulated Frame
- Triple Gasket System
- U-Value as low as 0.60Wm²k
- Passivhaus Certified

home pure

home soft

ambiente

Integrated Blinds

Concealed within the window for easy maintenance and operation. Available in Venetian or Duette for Blackout the integrated blinds can be controlled manually or powered by a Solar Panel with remote control.



KF410 Upvc/Alu Composite Window

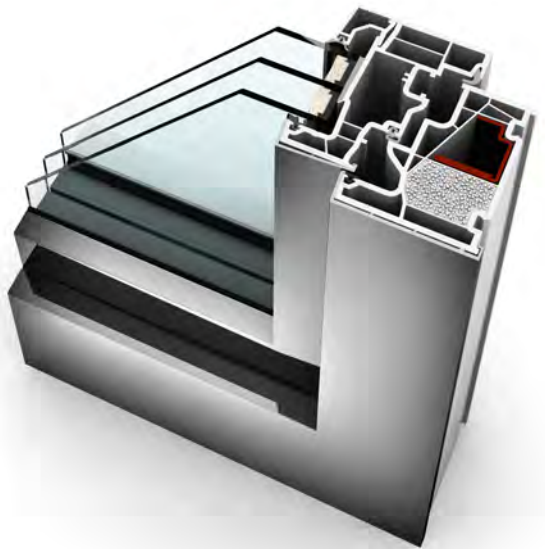

Properties:

- Tilt & Turn Window
- 93mm Frame Depth
- 114mm Sightline inc Opener
- Triple Glazed
- Foam Insulated Frame
- Triple Gasket System
- U-Value as low as 0.62Wm²k
- Passivhaus Certified

studio home pure home soft ambiente

KV440 Upvc/Alu Composite Window inc Integrated Blinds

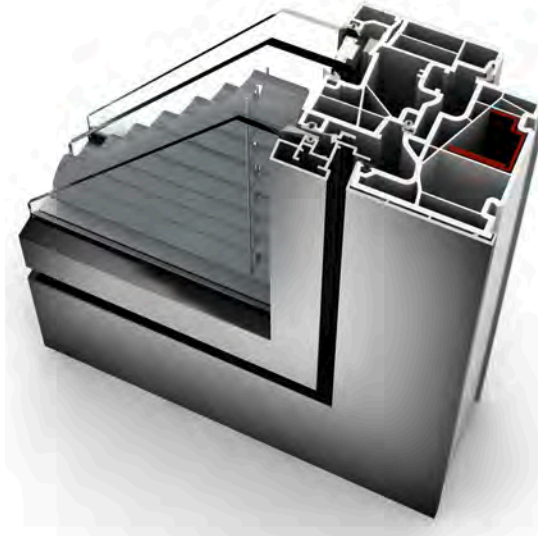

Properties:

- Tilt & Turn Window
- 93mm Frame Depth
- 114mm Sightline inc Opener
- 2+1 Glazing or 3+1 Glazing
- Foam Insulated Frame
- Triple Gasket System
- U-Value as low as 0.69Wm²k
- Passivhaus Certified

home pure home soft ambiente

Fully Reinforced



Insulated Frame



ITEC Ventilation



Integrated Blinds

Concealed within the window for easy maintenance and operation. Available in Venetian or Duette for Blackout the integrated blinds can be controlled manually or powered by a Solar Panel with remote control.



Internorm Lift & Slide Door

The timber/aluminium or upvc/aluminium lift-sliding door makes the borders between inside and outside disappear almost magically. It connects the inside space with the surrounding nature and creates a new, awareness of space.

The Lift & Slide offers unique design and exceptional comfort, combined with high-quality technology:

- More light through large-scale glazings
- Available up 11 m wide x 3.2 m height (HS330 only)
- Narrow sliding frame and frameless side elements
- Easy lifting and sliding of sash up to 400 kg sash weight
- Energy efficient and heating cost saving
- Low heat emission due to triple glazing
- No tripping hazard due to low threshold height
- Attractive colours for individual design requests
- Better stability due to glass fibre low threshold
- Toughened panes protect from injuries
- Can be perfectly combined with all other Internorm window systems

HS330 Timber/Aluminium



KS430 Upvc/Aluminium



Location: Cornwall

Type: Newbuild

Architect: SPS Architectural

Product: Internorm



AT530 Aluminium Entrance Door

PURISTIC – CREATES CLEAR LINES

The smooth door leaf and the square-edged frame creates clear lines which are further emphasized through straight-lined designer elements or glass cut-outs, bar handles as well as raised or flat heavy duty joiners.



Properties

- 93mm Frame Depth
- Triple Gasket Seal
- Square edged design
- Low Threshold
- U-Value as low as $0.75\text{Wm}^2\text{k}$
- PAS24 Certified

AT540 Aluminium Entrance Door

FLUSH DESIGN IN PERFECTION

The flush design of frame and door leaf is perfected through concealed hardware, level key hole cover plates, sunken recessed handles and heavy duty joiners as well as flat glass surrounds.



Properties

- 93mm Frame Depth
- Triple Gasket Seal
- Flush edged design
- Low Threshold
- U-Value as low as $0.78\text{Wm}^2\text{k}$
- PAS24 Certified



HT400 Timber Composite Entrance Door

PURISTIC LINES

The smooth door leaf and the square-edged frame create clear lines which are emphasized by continuous glass layers, straight-lined designer elements, bar handles as well as stainless steel attachments.



Properties

- 85mm Frame Depth
- Triple Gasket Seal
- Square edged design
- Insulated Timber Construction with Aluminium Clad
- Low Threshold
- U-Value as low as $0.73\text{Wm}^2\text{k}$
- PAS24 Certified

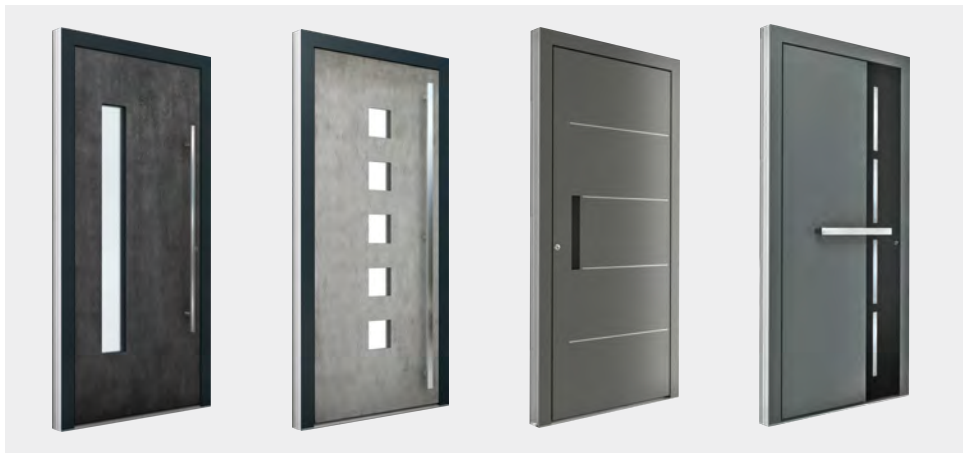

HT410 Timber Composite Entrance Door

FLUSH DESIGN

The smooth flow from frame and door leaf, concealed hardware, level key hole cover plates, recessed handles and millings as well as flat glass surrounds create the perfect design.



Properties

- 121mm Frame Depth
- Triple Gasket Seal
- Insulated Timber Construction with Aluminium Clad
- Flush Interior & exterior design
- Low Threshold
- U-Value as low as $0.58\text{Wm}^2\text{k}$
- PAS24 Certified



Internorm Colour Range

Standard External Colours



Hirest External Colours - Textured Finish



Spruce Internal Timber Finishes

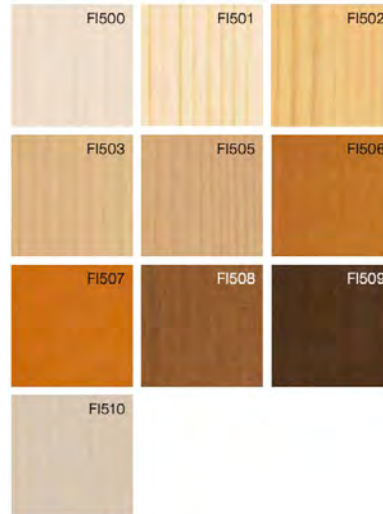

White Spruce



Ash



Walnut



Oak



Larch

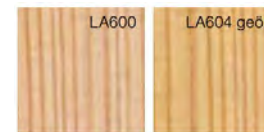

Upvc Internal Colour / Foil



Special External Entrance Door Finishes



*Please discuss with ecoHaus what finishes are available on each product.

Location: Surrey

Type: Newbuild

Architect: Nick Wilson Architects:

Products: Internorm & Visiline



Location: Northumberland

Type: Passivhaus Newbuild

Architect: Mawson Kerr

Products: Internorm



rational[®]

Timber & Timber Composite Windows:

Aura Timber Contemporary Window

Auraplus Timber Composite Contemporary Window

Forma Timber Traditional Window

Formaplus Timber Composite Contemporary Window

Lift & Slide Door

Flush Entrance Door

AURA Timber Window

AURA personifies clean lines. The sleek, flat frame gives your window a flush finish for a truly modern, Scandinavian feel. This is our most popular profile, especially for a stand-out “grand design”. Optional glazing bars can increase the architectural elegance of this style. Made from sustainably sourced timber, your windows and doors will last for decades if looked after.

Key Features:

- FSC Sustainable sourced Timber
- All Timber finish inside & out
- 60 year life expectancy
- Double or Triple Glazed option
- Twin Gasket seals
- Range of standard colours or choose any RAL colour
- Variety of Window Opening styles

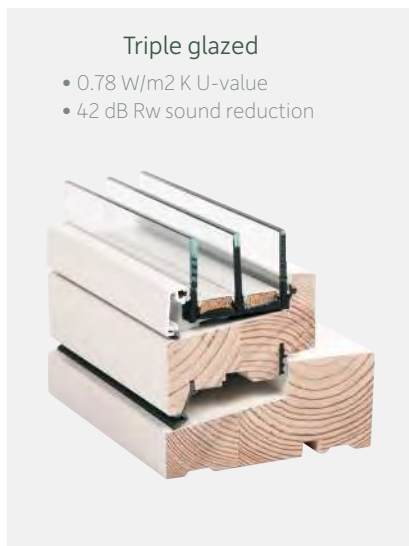

AURAPLUS Timber Alu-Clad Window

Choose AURAPLUS and we add aluminium cladding to the timber, which means maintenance becomes minimal and life expectancy rises by another 20+ years. The cladding comes in hundreds of colours and gives you the flexibility to have one colour inside your home and another on the outside. It can make a real impact and adds the durability to deal with the harshest of weather.

Key Features

- FSC Sustainable sourced Timber
- Alu Clad external finish
- 80 Year life expectancy
- Double or Triple Glazed option
- Twin Gasket seals
- Range of standard colours including dual colour option
- Variety of window opening styles

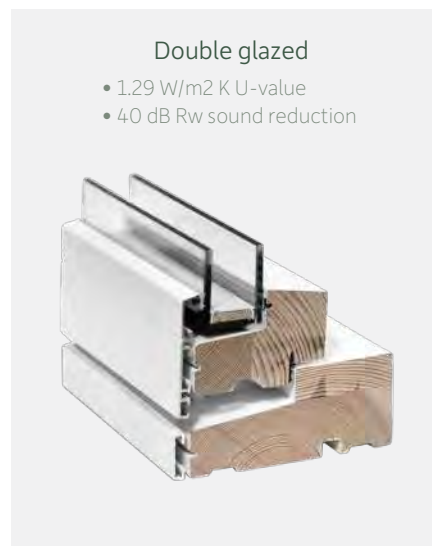

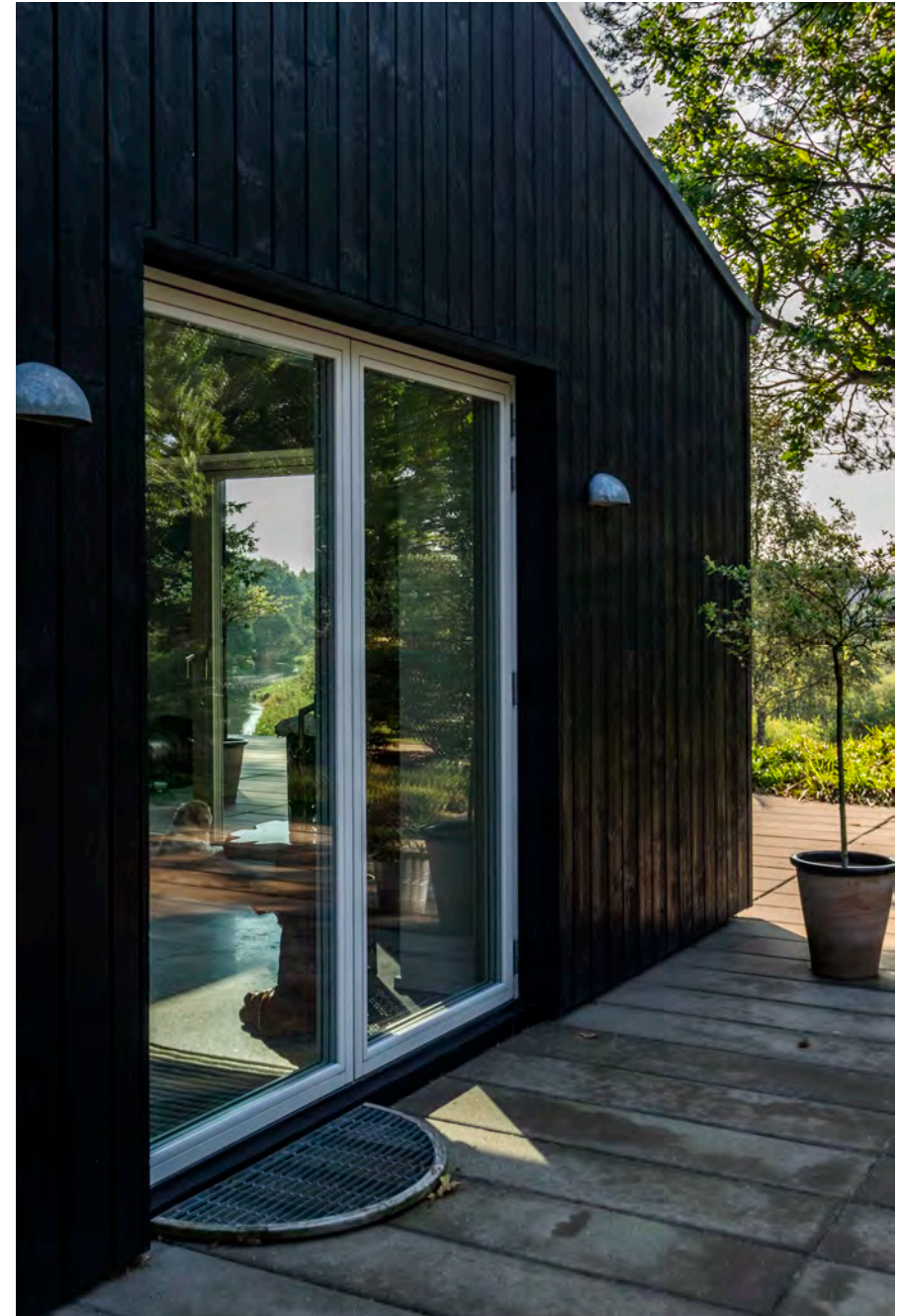

FORMA Timber Window

Designed to complement traditional British architecture, FORMA brings a softer line to your windows and ensures your project blends with its environment. Beautifully styled in sustainable timber that will last for decades, the bevelled edges bring a homely feel. The colour palette is extensive, with the most popular choices, you'll be choosing the same colour inside and out.

Key Features:

- FSC Sustainable sourced Timber
- All Timber finish inside & out
- 60 year life expectancy
- Double or Triple Glazed option
- Twin Gasket seals
- Range of standard colours or choose any RAL colour
- Variety of Window Opening styles



FORMAPLUS Timber Alu-Clad Window

Make it FORMAPLUS and the aluminium cladding gives you the option of another colour for the outside of your home – however, it's unlikely you'll want to cover up this beautiful styling. The cladded frame requires minimal maintenance and is extremely durable in all weather conditions. All styles are available with glazing bars, which particularly suit this style of window.

Key Features

- FSC Sustainable sourced Timber
- Alu Clad external finish
- 80 Year life expectancy
- Double or Triple Glazed option
- Twin Gasket seals
- Range of standard colours including dual colour option
- Variety of window opening styles





Lift & Slide Door

The Rational sliding patio doors are designed to be as beautiful as the outdoor view they frame. Highly-energy efficient, they work to bring the beauty of your garden into your home in the summer but keep the heat and enjoyment throughout the winter.

With a large glass area, this style of door maximises the amount of daylight coming into your home. Complete with energy-efficient panes, you can enjoy the views outdoors during any time of the year.

With sliding doors, you don't need to worry about whether you've got enough room. Since they have no swing area, sliding doors are suitable for any space you wish for your home. No matter what kind of space you're working with, you deserve the doors of your dreams.

Specification:

- Available in all Rational Standard Colours
- Maximum Overall width 3588mm
- Maximum Overall height 2388mm
- Available Double & Triple Glazed
- PAS24 Part Q Compliant





Flush Entrance Doors

Your front door isn't just the gateway to your house – it's your home's business card. It's your way of making a first impression, to those who land on your doorstep or those who pass by. And it's your family's security – so it needs to live up to the job. Our flush entrance door does just that.

Available either inward or outward opening, this door is side-hinged with visible and adjustable grey hinges. The doors are fitted with a three point espagnolette locking system and lockbox with latch and deadbolt.

Every product we make is totally bespoke, and our flush doors can be manufactured to incorporate whatever vision you might have for your big entrance. From a wide variety of patterns to a number of different vision panels (including oval, farmhouse, circle and diamond), the choice is completely yours.

Specification:

- Available in all Rational Standard Colours
- Fully Customizable Design
- Available Double & Triple Glazed
- PAS24 Part Q Compliant

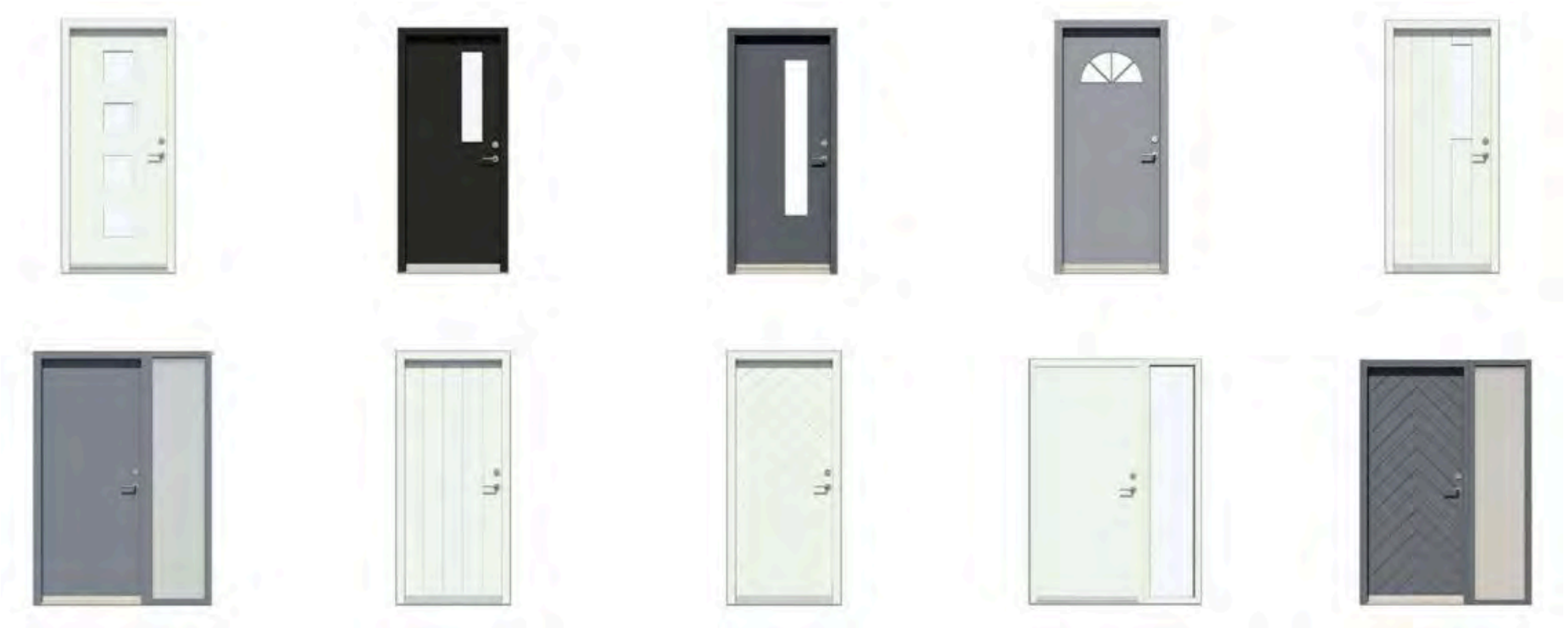



Location: Portsmouth

Type: Newbuild

Architect: HD Architects:

Products: Internorm



VELFAC®

VELFAC®

VELFAC composite windows bring together the best of both worlds; the durability and versatility of aluminium and the beauty and warmth of natural wood. Aluminium is both highly durable and low maintenance, ensuring the windows will last 40 years or more. The wood frame contributes to great energy performance with U-values as low as 0.8 W/m²k .

VELFAC 200 System aluminium/wood windows also deliver contemporary styling. The slim 54 mm sightlines maximise natural light, and opening and fixed lights have the same sightlines, providing a consistent aesthetic across window units.

Specification:

- U-Value as low as 0.8
- Equal 54mm Slim sightlines
- 48mm Triple Glazed as Standard
- Open Out Casement Window
- SBD Accredited
- 12 Year Warranty





Sales - Survey - Installation by a Company you can trust

Supplying a quality product is only part of the process. EcoHaus prides itself on being able to offer our clients a full service from start to finish;

Sales

By visiting one of our 5 Showrooms around the UK you will be able to see the products we offer and choose the right product to suit your project, from our Visiline Aluminium range or our Internorm Timber Composite range.

Survey

Following the Sales Process, one of our experienced Survey team will manage the process of ordering your windows, meeting your builder or architect and confirming the exact specification you require, taking all the stress away from you, the client.

Installation

Unlike a lot of companies we offer a full Nationwide Installation service by our own fully trained full time installers taking ownership and responsibility of the Installation of our own product to ensure exacting standards from start to finish.

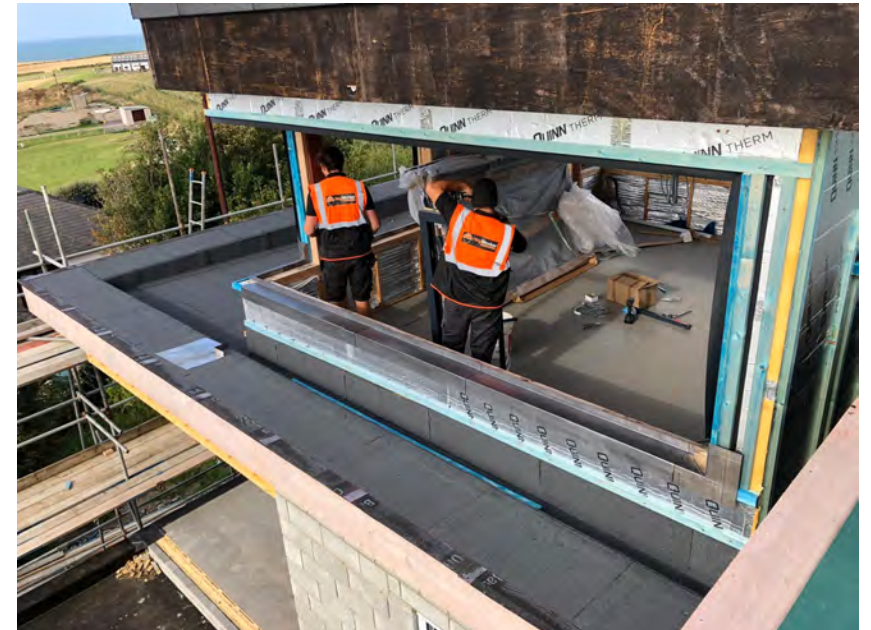

ecoHaus Showrooms

The ecoHaus showrooms are like no other, showcasing only the best in glazing solutions for your project. You can expect professional and expert advice from our product specialists. All of the products are on display ranging from Internorm Passivhaus windows, Visiline slimline sliding doors, Rationel timber composite windows as well as a huge range of Entrance Doors.

We advise all clients book an appointment prior to visiting the showroom so we can ensure one of our Product Specialists will be on hand to offer and advise and discuss your project in full.

Gloucestershire Showroom (Head Office)

Stroud Rd, Nailsworth. Gloucestershire. GL6 0BE

Surrey Showroom

Eashing Lane, Eashing, Godalming, Surrey. GU7 2QA

Cambridge Showroom

Bulse Grange, Duck Street, Saffron Walden, CB11 4JU

National Self Build & Renovation Centre Display Stand - You can see our **Internorm** Stand and **Visiline** Stand at the NSBRC Centre

NSBRC, Lydiards Fields, Great Western Way, Swindon. SN5 8UB

Swansea Showroom

Unit 1.19, Duffatty Park, Burry Port, SA16 0SA



T: 0800 612 6519
E: sales@ecohausuk.com
W: www.ecohausuk.com

ecoHaus

HEAD OFFICE
Gloucestershire Showroom
Stroud Rd
Nailsworth
Gloucestershire
GL6 0BE

Surrey Showroom
Unit 4 The Rickyard
Eashing Lane
Eashing
Surrey
GU7 2QA

Cambridge Showroom
Bulse Grange
Duck Street
Wendons Ambo
Saffron Walden
CB11 4JU

Swansea Showroom
Unit 1.20 Dyfatty Park
Burry Port
Carmarthenshire
SA16 0FB

National Self Build Centre
Lydiards Fields
Great Western Way
Swindon
SN5 8UB