

## Great Britain

Internorm Windows UK Ltd

Unit D · Colindale Business Park  
2–10 Carlisle Road · London, NW9 0HN  
Tel.: +44 (0) 208 205 9991 · Fax: +44 (0) 208 905 8744  
E-Mail: office@internorm.co.uk

## Austria

Internorm Fenster GmbH

A-1230 Wien · Vorarlberger Allee 27  
Tel.: +43 (1) 605 72-0 · Fax: +43 (1) 605 72-2125  
E-Mail: wien@internorm.com

A-4061 Pasching · Kremstal Straße 5  
Tel.: +43 (7229) 770-2440 · Fax: +43 (7229) 770-2433  
E-Mail: linz@internorm.com

A-6020 Innsbruck · Eduard-Bodem-Gasse 1  
Tel.: +43 (512) 36 10 48-0 · Fax: +43 (512) 36 10 48-2625  
E-Mail: innsbruck@internorm.com

A-8502 Lannach · Industriestr. 2  
Tel.: +43 (3136) 825 00-0 · Fax: +43 (3136) 825 00-2829  
E-Mail: lannach@internorm.com

## Germany

Internorm-Fenster GmbH

Zentrale Deutschland  
D-93059 Regensburg · Nußbergerstr. 6b  
Tel.: +49 (941) 464 04-0 · Fax: +49 (941) 464 04-22 40  
E-Mail: regensburg@internorm.com

Vertriebsniederlassung Berlin  
D-12623 Berlin · Landsberger Str. 267  
Tel.: +49 (30) 340 44 17-0 · Fax: +49 (30) 340 44 17-99  
E-Mail: berlin@internorm.com

## Switzerland

Internorm-Fenster AG

CH-6330 Cham · Gewerbestr. 5  
E-Mail: cham@internorm.com

Ausstellung Ostschweiz  
CH-9434 Au · Berneckerstr. 15  
Tel.: +41 (0) 71 747 59 59 · Fax: +41 (0) 71 747 59 58  
E-Mail: au@internorm.com

Ausstellung Mittelland  
CH-5502 Hunzenschwil · Römerstrasse 25  
Tel.: +41 (0) 62 926 07 52 · Fax: +41 (0) 62 926 07 54  
E-Mail: mittelland@internorm.com

Salle d'Exposition Suisse Romande  
CH-1030 Bussigny-près-Lausanne VD · Rue de l'Industrie 58  
Tel.: +41 (0) 22 364 67 33 · Fax: +41 (0) 22 364 86 22  
E-Mail: romandie@internorm.com

## France

Internorm Fenêtres SAS

BP 20073 · 10 rue Alcide de Gasperi  
Zone Espale  
F-68392 SAUSHEIM CEDEX  
Tél.: +33 (3) 89 31 68 10 · Fax: +33 (3) 89 61 81 69  
E-Mail: sausheim@internorm.com

## Italy

Internorm Italia S.r.l.

I-38121 Gardolo (TN) · Via Bolzano, 34  
Tel.: +39 (0461) 95 75 11 · Fax: +39 (0461) 96 10 90  
E-Mail: italia@internorm.com

## Slovenia

Internorm okna d.o.o.

SLO-1000 Ljubljana · Koseška cesta 8  
Tel.: +386 (1) 581 92 55 · Fax: +386 (1) 581 92 57  
E-Mail: internorm.okna@siol.net

## Czech Republic

Internorm-okno, s.r.o.

CZ-162 00 Praha 6  
Na Okraji 439/46A · Velešlavin  
Tel.: +420 235 09 04 41-43  
E-Mail: internorm@internorm.cz

## Slovakia

Internorm s.r.o.

SK-821 04 Bratislava · Galvániho 15/B  
Tel.: +421 (2) 436 327 82 · Fax: +421 (2) 436 327 83  
E-Mail: office@internorm-okna.sk

## Hungary

Internorm Ablak Kft.

Nyugati u. 10300/13  
H-2040 Budaörs · Budapark  
Tel.: +36 (23) 920 100  
E-Mail: internorm@internorm.hu

# BOOKLET

OPERATING INSTRUCTIONS. CARE.  
MAINTENANCE. WARRANTIES

Your personal order number

Date	Stamp, signature

## WARRANTIES

### Warranty

**10**  
YEARS

- No unnatural colour changes or cracked surfaces due to weather influences for white window and door profiles made of UPVC, with the exception of mitre cracks.
- No unnatural colour changes or cracked inside surfaces due to weather influences for foil-coated window and door profiles made of UPVC, with the exception of mitre cracks.
- No unnatural colour changes or cracked surfaces due to weather influences for anodised or powder coated window and door profiles made of aluminium.
- No condensation between the panes of insulating glass.
- The function of the timber, thermal foam and aluminium profiles compounds is guaranteed for all Internorm timber/aluminium window systems, provided that the Internorm installation and maintenance guidelines have been adhered to.
- The function of the adhesive and the sealing of insulation glass panes with the window profiles is guaranteed for all Internorm timber/aluminium window systems, provided that the Internorm installation and maintenance guidelines have been adhered to.
- The glue connection of glued Georgian/feature bars.

### Warranty

**5**  
YEARS

- PVD coated door handles are guaranteed against corrosion if there is no mechanical change.
- No unnatural colour changes or surface cracks due to weather influences in door fillings. There is no guarantee for changes in the surface appearance as a result of dirt.

### Warranty

**3**  
YEARS

- No unnatural colour changes or surface cracks due to weather influences for roller shutter profiles made of UPVC.
- No unnatural colour changes or surface cracks due to weather influences for anodised or powder coated roller shutter and blind profiles made of aluminium.
- The function of the window or door fittings is guaranteed, provided that the Internorm installation and maintenance guidelines have been adhered to.

### Assurance

**30**  
YEARS

Furthermore Internorm guarantees safe-guarding that Internorm products can be repeatedly serviced by our experts in such a fashion (original parts not obligatory), to retain their full function for a period of 30 years. However, this presupposes that the frame construction (frame and sash) is not damaged. The 30-year period starts from the production date. The services required to maintain the functionality, including the materials required, labour etc. will be invoiced according to the currently valid rates.

## CONTENT

### Congratulations!

You have decided for an Internorm product which belongs to the very first choice in quality, technical perfection and design. This is based upon the technical know-how of over 85 years of experience in window construction. By choosing Internorm you have chosen the security of Europe's largest window brand.

<b>1. Product liability and warnings</b>	<b>2</b>
<b>2. Operation</b>	<b>8</b>
2.1. Windows and window doors	8
2.2. Sliding elements	12
2.3. Entrance doors	14
2.4. Sun and insect protection	32
2.5. I-tec Ventilation	36
2.5.1. ventilator IV30	36
2.5.2. ventilator IV40	40
2.6. I-tec shading	49
2.7. Opening control (wireless)	52
<b>3. Adjustments – adjustment possibilities</b>	<b>54</b>
3.1. Concealed hardware	54
3.1.1. VV hardware	54
3.1.2. VV hardware (concealed TopStar)	58
3.1.3. I-tec locking	60
3.2. Exposed hardware	63
3.3. Further hardware versions	66
3.4. Entrance doors	76
3.5. Available adjustments for window shutters	93
3.6. Insect protection	94
<b>4. Cleaning, care and maintenance</b>	<b>95</b>
4.1. General information	95
4.2. Hardware	96
4.3. Cleaning tips for glass surface/glass joint/glass corner	96
4.4. Gaskets	97
4.5. UPVC surfaces	98
4.6. Timber surfaces with timber/aluminium elements	98
4.7. Anodised or powder coated aluminium surfaces	98
4.7.1. Requirements and process for cleaning aluminium surfaces	99
4.7.2. Cleaner for anodised surfaces	100
4.7.2.1. Conservation for anodised surfaces	100
4.7.3. Cleaning for powder coated surfaces	101
4.7.3.1. Conservation for powder coated surfaces	102
4.8. Cleaning instructions for stainless steel	103
4.9. Care and maintenance of the I-tec ventilation system	103
4.10. Special warning for timber/aluminium elements	104
<b>5. Comfort</b>	<b>105</b>
<b>6. Airing</b>	<b>106</b>
<b>7. Warranties</b>	<b>109</b>
7.1. General information	113
7.2. Fitting advice	114
7.3. Technical limitations of the warranty	115



ENJOY YOUR NEW  
WINDOWS AND DOORS  
FROM INTERNORM.

You have chosen well by buying quality products from Internorm.

Many thanks again for your trust! For questions which this booklet cannot answer, please phone our head-office in London on:

**0208 205 9991**

Or send us an email: [office@internorm.co.uk](mailto:office@internorm.co.uk)  
More information is also available on [www.internorm.co.uk](http://www.internorm.co.uk)

## 1. PRODUCT LIABILITY AND WARNINGS

### General Information

Internorm windows, doors, sun protection elements and accessories are high-quality products. In order to ensure their lasting serviceability and durability as well as to prevent personal and material damage, their professional service and maintenance is essential. In this manual you will find basic information to this end. Disregard of this information can lead to exclusion from warranty and product liability claims. Functional impairments or wear and tear of parts, which usually occur within the limits of normal and proper use, are not covered by warranty obligations. Excluded are also any damage which is the result of improper handling, unintended use of the product and attempts of repair by unqualified persons. The intended product use of windows and doors includes the opening and closing of sashes fixed at vertically installed elements. When closing the sash, the counterforce of gaskets has to be overcome. All other kinds of use do not correspond with the intended use.



#### **Please consider the following points:**

The opening gap between the sash and the frame can pose a risk of injury through jamming.



When the window is open, there is a risk of falling down - great danger for children.



When the window sash is open, there is a risk of injury through the effects of wind and storms.



Avoid additional load on the sash (not intended as coat hanger or stepladder).

## 1. PRODUCT LIABILITY AND WARNINGS

Internorm®



Please take care that no objects can get between the sash and the frame and that no objects are jammed when closing the window.



Please avoid sashes being pressed against window frames contrary to normal use or in an uncontrolled manner (e.g. through wind load), which may result in damage of hardware, destruction or consecutive damage of hardware, frame materials or other parts of the window or door.



In case of wind and draught, window and door sashes must be closed and locked.



Opened and tilted sashed do not meet the requirements for impermeability of joint seals, driving rain impermeability, sound insulation, heat insulation and anti-burglary protection.



Closed windows do not meet the requirements for airing necessary for maintaining good health and heating. If the windows are used for airing rooms, this has to be done on a regular basis implementing proper airing habits.



Normal glass does not meet any requirements for increased risk of breakage, anti-burglary protection and fire protection.



Normal glass can break easily. The resulting sharp glass edges and glass splinters pose a risk of injury.



Entrance doors that have not been locked properly (e.g. locked only via the latch) do not meet the requirements for anti-burglary protection.



Security related hardware has to be checked regularly regarding its tight fitting and corrosion. If required, fixing screws must be tightened or parts have to be exchanged.

## 1. PRODUCT LIABILITY AND WARNINGS

Internorm®



Please store separately delivered glass in a dry place --> Moisture destroys the edge area.



All window and door elements which are designed to be opened, closed and locked have to be operated at least once a month to avoid damage through "inoperative wear and tear" (especially corrosion and stiffness).



During construction works many mechanical, climatic and chemical strains have an effect on windows and doors. Consequently, protect the construction elements by covering them and ensure proper aeration in order to regulate humidity.



Please protect timber/aluminium elements during construction works from humidity, rain and snow. There are openings for vapour pressure compensation of the profiles in between the aluminium and timber profiles. Please protect these joints from humidity until the building connection is established.



Please use appropriate adhesive tapes for protecting the surfaces. The adhesive tapes have to be compatible with timber, plastic and aluminium surfaces. The adhesive tapes must be removed as soon as possible, when they are no longer needed.



Wet mortar, concrete and plastering materials can cause massive permanent stains - especially with timber type larch. This is caused by a chemical reaction with the timber components (tannic acid). Protect your timber surfaces during construction works with suitable masking materials.



Should despite careful handling, any staining remain on the construction elements, these must be removed promptly and completely using mild detergents.

## 1. PRODUCT LIABILITY AND WARNINGS

Internorm®



Please avoid formation of too much humidity (max. 50 % at 20 °C). It leads to consecutive damage like swelling of timber parts, damage of painted surfaces (door panels), deformation of construction parts, formation of mould and an unhealthy living climate. The effects of too much humidity have to be avoided especially also during particular construction periods (inside plastering or screed work).



Alkaline leachates from the facade and walls can cause irreversible damage on powder-coated and anodised aluminium surfaces. To avoid this, the window and door frames have to be cleaned and conserved in time.



Insect excrements, pollen, soot particles, iron dust (wear from rail tracks) and similar things can, in combination with rain water and intensive UV radiation, cause staining on UPVC surfaces which are hard to remove and cannot be tackled with regular household cleaner. Therefore, the contact time of such stains should be kept as short as possible. The frame profiles have to be cleaned as soon as possible if such stains occur. Protect the affected profiles with suitable means.



Sharp edges of functional elements can lead to injury when door and window elements are handled wrongly, especially when someone sits or stands partially or fully under an opened sash.



Please take care that for concealed hardware the turn limiter is snapped into place in the bolt in the corner hinge.

## 1. PRODUCT LIABILITY AND WARNINGS

Internorm®



If doors have been fitted with turning hinges, which are screwed into the sash protrusion, the sash has to be protected against „reveal impact“ through a stopper fitted on site. Otherwise there is a risk of damage due to the enormous forces which affect the turning hinges



Security construction parts like turn limiters and stay-arms must only be unlocked by qualified personnel in order to adjust or unhinge a sash.



Increased thermal load and heat accumulation on the glass can lead to spontaneous glass breakages. Avoid part-shading of glass which is caused through external sun protection systems. Heat accumulation on the glass results from heat sources (radiator, lights) and during sun exposure from very dark objects which are too near the glass on the inside or outside. Avoid attaching foils and paints to the glass later.



Panel fillings in sound protection versions have insulating glass built into the core. These panels must not be machined in any way (drilling, cutting) and have to be protected from excessive shock and impact forces.



Do not drill into door profiles or designer fillings. (E.g. for door spy holes, knockers, ... ). Partly, there is insulating glazing behind a cover layer. You could possibly destroy the door sash.

Before using the windows, security related hardware and hardware accessories have to be tested for safe functioning (e.g. lockable window handle, turn stop, rebate and cleaning stay-arm security, turn and opening limiter, etc.) and if necessary have to be adjusted by qualified personnel. Nonobservance of this can lead to damage on property and persons.

## 1. PRODUCT LIABILITY AND WARNINGS

Internorm®



With the all-glass attachment sash (studio), the security clamps at the bottom and top must not be removed or changed.



Protect material surrounding the window or door element which is not waterproof (especially sills or timber floors) from possible condensation.



Handles and levers must not be used as carrying aids.

### Wrong handling



If the window handle is brought into tilt position when the window is open, the sash will loosen from the top locking mechanism. In order to avoid injury or damage, please proceed as follows:

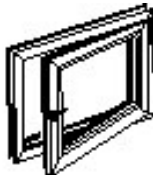

Keep the window handle in tilt position and press the sash onto the frame at the side of the stay-arm, and turn the handle (90°) into turn position.

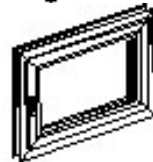

Then close the window and turn the window handle into locking position (turn 90°). Now you can tilt or open the window sash again without any problems.

## 2. OPERATION

Internorm®

## 2. OPERATION

### 2.1. Windows and window doors

#### Turn-tilt version

The sash can be turned via positioning the handle horizontally and tilted via positioning the handle vertically.

Tilt window

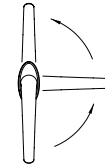

Open window  
Turn position

Close and lock  
window

#### Turn version

Positioning the handle vertically upwards is not possible.

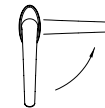

Open window  
Turn position

Close and lock  
window

#### Tilt version (KGO)

The handle is mounted in the centre at the top. Positioning the handle vertically upwards is not possible.

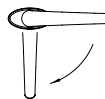

Close and lock  
window

Open window,  
Tilt position

#### Tilt version (KG)

The sash can be tilted by positioning the handle vertically and horizontally. Due to technical reasons, the handle can only be turned horizontally for tilting sashes with certain sash sizes.

Tilt window

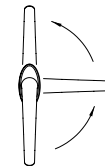

Tilt window

Close and lock  
window

## 2. OPERATION

# Internorm®

### Fanlight version (KAZ)

The sash is operated via a pull rod. When the pull rod is pressed down, the sash is brought into tilt position.

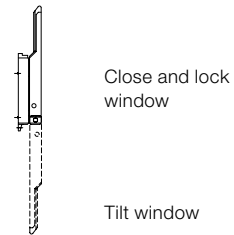

### Fanlight version (KAK)

The sash is operated via a crank handle. For opening the sash the crank handle is taken out of the wall bracket, folded (as shown in the drawing) and positioned into tilt position by turning the crank handle.

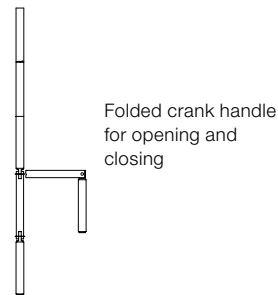

### Lockable turn/turn-tilt door

The door can be turned by positioning the handle horizontally and tilted by positioning the handle vertically. In this version the drive stroke is locked by the cylinder, i.e. the handle cannot be operated any longer. The door can be locked in the closing as well as in the tilt position

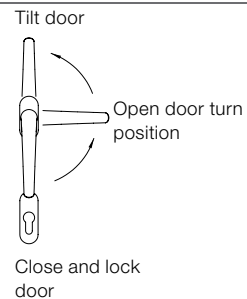

### Multi-point locking turn door

By pressing the lever handle down, the latch is drawn back and the door can be opened. The lever handle bounces back. For locking the door, the lever handle must be pressed upwards by 45°, all the locking elements lock and the profile cylinder can be locked. For opening the door, the cylinder must be operated first and only then the lever handle can be pressed down and the door can be opened.

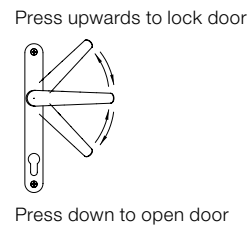

## 2. OPERATION

# Internorm®

### Deadbolt lock turn door

By pressing the lever handle down or operating the cylinder (contrary to locking direction) the latch is drawn back and the door can be opened. The lever bounces back. The door is locked with the bolt, which is operated via the locking cylinder (extending the bolt). The lever can also be operated when the lock is locked.

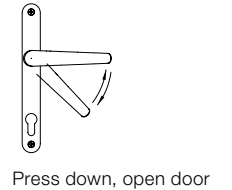

### Side entrance door

By pressing the lever handle down or operating the cylinder (contrary to locking direction) the latch is drawn back and the door can be opened. The lever bounces back. The door is locked via the bolt and the locking pins, which are operated via the locking cylinder (two full turns)

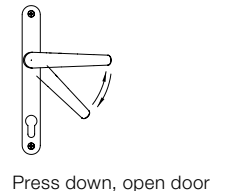

### 3 sash window without transom (model 50)

In order to avoid damage of the sashes, the opening sequence had to be adhered to:

**For opening:** First both end sashes, then centre sash!

**For closing:** First the centre sash, then both end sashes!

### Flying mullion sash drive

The flying mullion lever is folded flush in closed position.

Release the flying mullion lever by pressing the blue button.

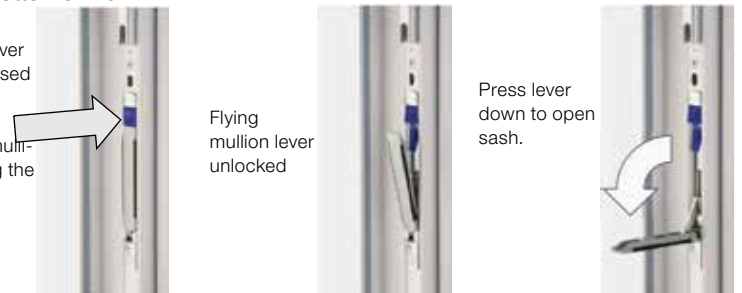

## 2. OPERATION

Internorm®

### Attachment sash composite window

The locks of the attachment sash are only accessible when the window sash is open. The locks are positioned on the inside of the drive between the window sash and the attachment sash. Take out locking latches by 90° and open attachment sash. Please take care that all locking latches have been locked into place before locking the sash again.



By closing the vent slots with a grid you can prevent insects entering in summer.



Open up the vents again in winter to ensure good ventilation. This should help prevent misting up and condensation.



## 2. OPERATION

Internorm®

### 2.2. Sliding elements

#### Parallel sliding window/door

Turn the handle horizontally for sliding function, afterwards position the sash parallel by pulling the handle and slide to the side. For closing, push the sash so far until it swerves back into the locking position again.

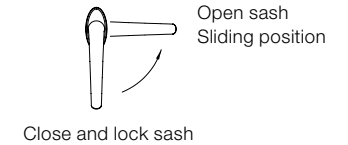

#### Lift-sliding door

For opening and sliding of the sash, turn the handle completely down. The sash can be lowered either in the locking position, airing position or any other open position. It is then secured against sliding.

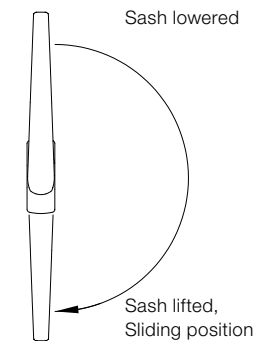

Turn handle down, sash is lifted:  
=sliding position

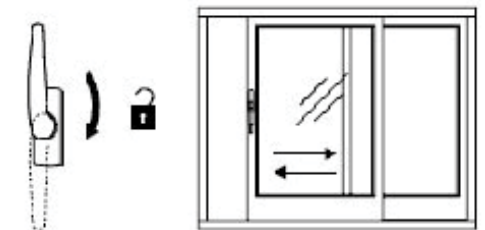



## 2. OPERATION

Internorm®

Sash lowered at 11 mm opening: = secured airing position

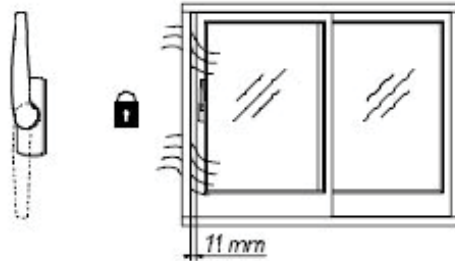

**Only lower sliding sash when not in movement!**  
If sash is lowered while sliding, damage at the bottom sash gaskets can occur and it is wrong handling!

### Side adjustment deadbolt

To avoid collisions of the deadbolt with the drive, these can be adjusted at the side.

(only applies to schemes A and C)

Loosen both screws, move deadbolt in parallel and tighten screws again.



## 2. OPERATION

Internorm®

### 2.3. Entrance doors

Internorm entrance doors are available with a variety of different lock types, whose operation differs one from the other.

Below an overview of the basic functions of the locking systems

Lock types for aluminium entrance doors:

	Verschlusspunkte	Schließvorgang	Öffnungsvorgang	Auswertungen	Tagbetrieb *)
<b>MVB</b>	Hauptriegel + 2 Bolzen	manuell mechanisch	manuell mechanisch	nein	-
<b>MV</b>	Hauptriegel + 2 Bolzen-Schwenkriegel	manuell mechanisch	manuell mechanisch	nein	-
<b>MV mit TSH</b>	Hauptriegel + 2 Bolzen-Schwenkriegel	manuell mechanisch	manuell mechanisch	nein	-
<b>MV-AM</b>	Hauptriegel + 2 Schwenkriegel	<b>automatisch mechanisch</b>	manuell mechanisch/ Innendrücker	nein	mechanisch (optional)
<b>EE</b>	Hauptriegel + 2 Schwenkriegel	<b>automatisch mechanisch</b>	automatisch <b>elektrisch</b> / Innendrücker	nein	mechanisch (optional)
<b>EVE</b>	Hauptriegel + 2 Bolzen-Schwenkriegel	automatisch <b>elektrisch</b>	automatisch <b>elektrisch</b>	ja	elektrisch
<b>EVC</b>	Hauptriegel + 2 Bolzen-Schwenkriegel	automatisch <b>elektrisch</b>	automatisch <b>elektrisch</b> / Innendrücker	ja	elektrisch
<b>FRS / RS</b>	Hauptriegel	manuell mechanisch	manuell mechanisch	nein	-

\*) Day operation: No automatical locking when closing (switchable)



### Emergency door locks acc. to EN179 and EN1125:

Operation manuals for emergency door locks are not part of this Maintenance, care and warranty booklet. They will be described separately in special instructions.

Lock types with timber/aluminium entrance doors

	Locking process	Opening process	Day operation *)
<b>MV</b> (hookLock M)	manual mechanical	manual mechanical	-
<b>AV3</b> (autoLock)	<b>automatic mechanical</b>	manual mechanical/ inside lever	mechanical
<b>EAV3</b> (blueMatic)	<b>automatic mechanical</b>	automatic <b>electrical</b> / inside lever	mechanical
<b>blueMotion</b>	automatic <b>electrical</b>	automatic <b>electrical</b> / inside lever	electrical

\*) Day operation: No automatic locking when closing (switchable)



Only a locked door will provide security!

Locking / unlocking and opening - *manual*



Manual locking of door

Full turn/s (1 or 2 turns) of the key in locking direction → all locking elements engage.



Manual unlocking of door (from locked state)

Full turn/s (1 or 2 turns) of the key opposite to locking direction → all locking elements retract.



Opening of door - lever (from unlocked state)

**Lever** present – press lever down → latch retracts, door opens.



Opening of door - fixed handle (from unlocked state)

**No lever** present – turn key opposite to locking direction for a full turn. This retracts the catch. Push door sash opposite to opening direction → this releases load on the latch, door opens

## 2. OPERATION

# Internorm®

### FRS (Latch-bolt lock)

Type: Mortise lock with latch and bolt

Locking element:

1 main bolt

Locking, unlocking: 1 full turn of key

(Detailed description page 16)

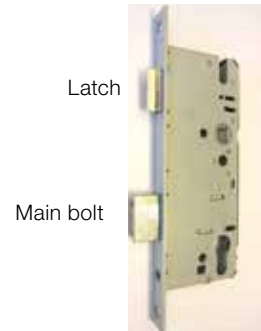

### RS (Bolt lock)

Type: Mortise lock with bolt

Locking element:

1 main bolt

Locking, unlocking: 1 full turn of key

(Detailed description page 16)

Please note:

As this door features no latch, the door sash will only stay closed in locked state or via an additional catch or door closer.

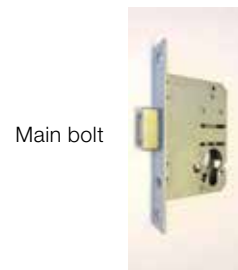

## 2. OPERATION

# Internorm®

### MVB (Multi-point locking "Bolt"- manual)

Type: 3-point locking

Locking elements:

1 Main bolt - 2 bolts

Locking, unlocking: 2 full turns of key

(Detailed description page 16)

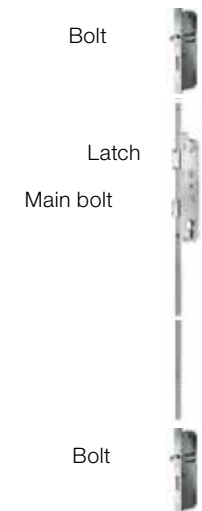

### MV (Multi-point locking - manual)

Type: 5-point locking

Locking elements:

1 main bolt - 2 bolts - 2 hook bolts

Locking, unlocking: 2 full turns of key

(Detailed description page 16)

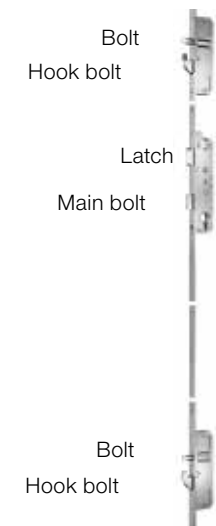

## 2. OPERATION

# Internorm®

### MV -AM (Multi-point locking - automatic-mechanical)

Type: 3-point locking

Locking elements:

1 main bolt - 2 hook bolts

Locking: Automatic-mechanical after closing of door  
(2 hook bolts engage)

Unlocking:

Outside: Manually via key

Inside: Manually via lever

Additional locking:

In locked state, the main bolt can additionally be engaged via the key.

→ additional security (e.g.: during longer absence)

The inside lever is blocked with this position.

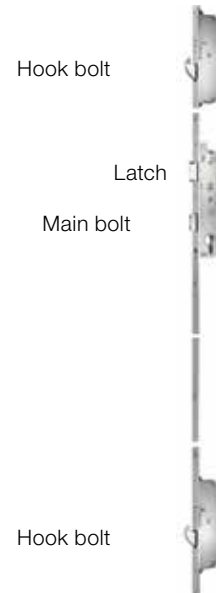

## 2. OPERATION

# Internorm®

### EE (Multi-point locking - half motoric)

Type: 3-point locking

Locking elements:

1 main bolt - 2 hook bolts

Locking: Automatic-mechanical after closing of door  
(2 hook bolts engage)

Unlocking:

Outside: Via access control system (fingerprint, transponder,...)

Inside: Manually via lever

Additional locking:

In locked state, the main bolt can additionally be engaged via the key.

→ additional security (e.g.: during longer absence)

The inside lever and the access control system are blocked with this position.

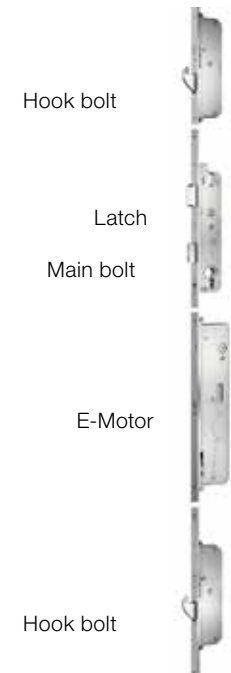

**While the motoric unlocking process is taking place, no operation of the lever is allowed.**

→ **Danger of damage to lock!**

**Day unlocking module for EE and MV-AM (optional)**

In switching position, this manual slider which is positioned on the lock flying mullion, can prevent the hookbolts automatically locking.

→ Door is only held with locking latch

This enables use of an electric door opener (ETÖ) or a mechanical day latch (MTOE).

Change of switching position day unlocking: Before changing switching position of slider, the **lever needs to be pressed down completely at the same time!**



Slider for change in switching position



A door which is only held in place via the lock latch, does NOT count as locked. Only locked doors provide security!

**EV-E (Multi-point locking - fully motoric)**

Type: 5-point locking

Locking elements:

1 main bolt - 2 bolts -2 hook bolts

Locking: Automatic-electromotive after closing of door (all 5 locking elements)

Unlocking:

Outside: Via access control system (fingerprint, transponder,...)

All locking elements and latch are retracted for max. 7 seconds. If door is not opened during this time, an automatic locking process sets in.

Inside: Via electro key

Emergency operation via key is available!

Day operation - can be switched electrically:

In this position no automatic locking occurs. The door bolt is only held via the lock latch.

→ The use of an electric door opener (ETÖ) or a mechanical day latch (MTOE) is therefore available.

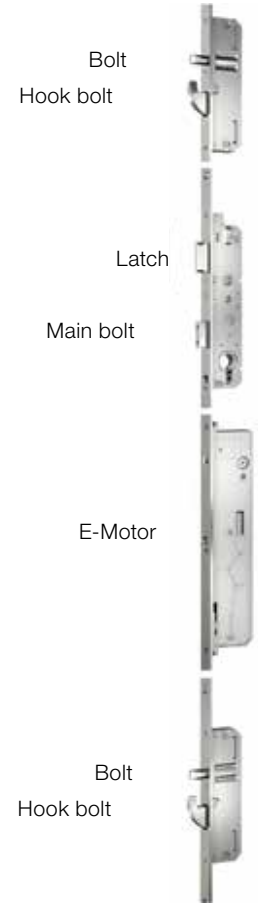

A door which is only held in place via the lock latch, does NOT count as locked. Only locked doors provide security!



Leave NO keys in the locks.

## 2. OPERATION

# Internorm®

### EV-C (Multi-point locking - fully motoric)

With EV-C opening from the locked state via inside lever is additionally available.

→ Comfort!

All other features and remaining functions are identical to EV-E → see page 21



**While the motoric locking or unlocking process is taking place, no operation of the lever is allowed.**

→ **Danger of damage to lock!**



Leave NO keys in the locks.

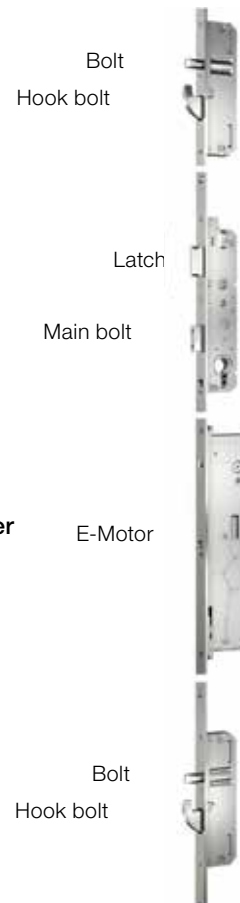

## 2. OPERATION

# Internorm®

### MV (hookLock M- Multi-point locking - manual)

Type: 3-point locking

Hook bolt

Locking elements:

1 main bolt - 2 hook bolts

Locking, unlocking: 2 full turns of key  
(Detailed description page 17)

### AV3 (autoLock Multi-point locking - ~~auto-mechanical~~)

Type: 3-point locking

Latch

Main bolt

Hook bolt

Locking elements:

1 main bolt - 2 hook bolts

Locking: Automatic-mechanical after closing of door  
(2 hook bolts and 2 sealing bolts engage)

Unlocking:

Outside: Manually via key

Inside: Manually via lever

Additional locking:

In locked state additionally the main bolt can be engaged via the key.

--> Additional security (e.g.: during longer absence)

The inside lever is blocked in this position

Day operation- mechanically switchable:

In this position no automatic locking takes place. The door is only held by the lock latch.

Hook bolt

Latch

Main bolt

Hook bolt

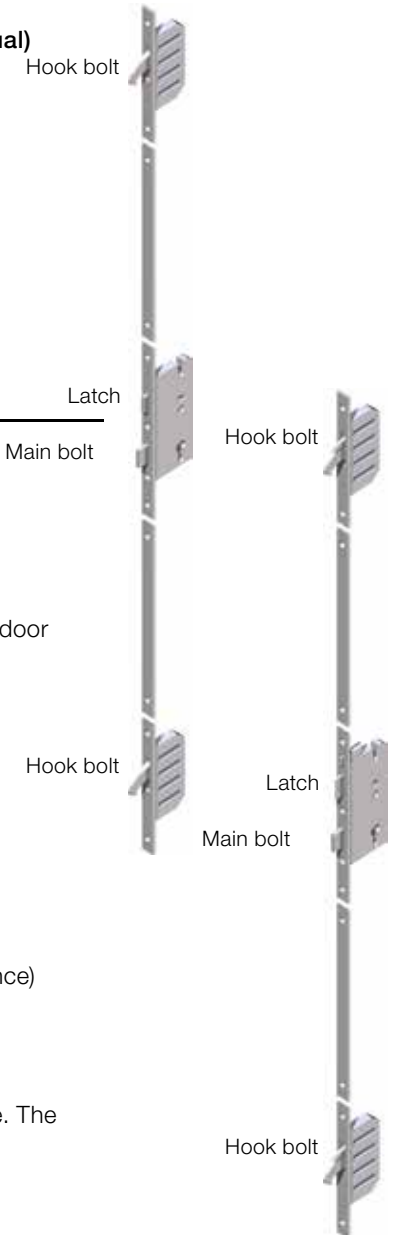

## 2. OPERATION

Internorm®

### EAV3 (blueMatic Multi-point locking - half motoric)

Type: 3-point locking

Locking elements:

1 main bolt - 2 hook bolts

Locking: Automatic-mechanical after closing of door  
(2 hook bolts and 2 sealing bolts engage)

Unlocking:

Outside: Via access control system (fingerprint, ...)

Inside: Manually via lever

Additional locking:

In locked state additionally the main bolt can be engaged via the key.

--> Additional security (e.g.: during longer absence)

The inside lever and the access control system are blocked in this position.

Day operation- mechanically switchable:

In this position no automatic locking takes place. The door is only held by the lock latch.

Hook bolt

E-Motor

Latch

Main bolt

Hook bolt



## 2. OPERATION

Internorm®

### blueMotion (Multi-point locking - fully motoric)

Type: 3-point locking

Locking elements:

1 main bolt - 2 hook bolts

Locking: Automatic-electromotive after closing of door  
(all 3 locking elements)

Unlocking:

Outside: Via key or access control system  
(fingerprint,...)

If door is not opened after unlocking, automatic locking sets in after 8 seconds

Inside: Via lever

Day operation - electrically switchable:

In this position no automatic locking takes place. The door is only held via the lock catch.

--> Therefore, use of an electric door opener (ETÖ) is available.

Hook bolt

Latch

Main bolt

E-Motor

Hook bolt



Leave NO keys in the locks.

## Accessories

**Integrated door block (MV with TSH)**

1 - Door limiter - integrated into striking bead



2 - Bolt - integrated into multi-point locking



3 - Turn knob - on inside of door sash

**Opening of door from outside when TSH (integrated door block) is activated:**

1. When door locked, 2 full turns of key opposite to locking direction.
2. One full turn of key in locking direction  
→ bolt of TSH retracts
3. One full turn of key opposite to locking direction. Lock latch is retracted and door can be opened.

**To activate/deactivate door block TSH from inside:**

Carried out via turn knob on inside of door sash. (approx. 90° turn)

Door limiter in operation

**Electric door opener (ETÖ)**

Only for doors with fixed handle (no lever) on the outside.

Normal position: Door is kept closed via latch. When released by electric signal door can be opened by simply pushing against it.  
(only if door is not locked)

Day unlocking: Door can be pushed open any time  
(only if door is not locked).

ETOE: Door can only be opened during electric signal is given.

ETOA: Door stays open after signal has been given once until door sash is opened once.

Technical data:

10- 24 Volt

Direct and alternating current (DC/ AC)

Mechanical day unlocking

The ETÖ is suitable for 100% power on between 10-13V DC (direct current).



Slider for change between normal position and day unlocking

A door which is only held in place via the lock latch, does NOT count as locked. Only locked doors provide security!



Only professional personnel is allowed to carry out the electrical connection!

Emergency doors feature different electric door openers.





Certain types of ETOA are activated through electric contacts independent of the door sash position (open - closed)  
If a new opening impulse takes place or the electric opening signal is still there while the door is already open, then the door needs to be opened one more time!



If the door is only kept by the catch (ETÖ operation), always check after closing of the door sash that the door sash is properly engaged. (cannot be opened without lever/key)

### Mechanical day latch (MTOE)

Only for doors with fixed handle (no lever) on outside

Day latch activated:

The door can be opened by simply pushing against if not locked.

Activating slider

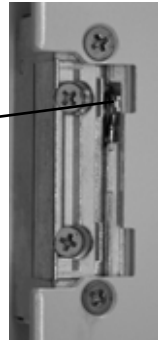

Day latch not activated:

The door holds via the lock latch if not locked.

Please note:

Door should be equipped with additional catch or door closer, as pressure of gasket could press door open of its own accord!



A door which is only held in place via the lock latch, does NOT count as locked. Only locked doors provide security!



If the door is only kept by the latch (MTOE operation), always check after closing the door sash that the door sash is properly engaged. (cannot be opened without lever/key)

**Shoot bolt (only with 2-sash elements)**

Locking of the slave sash: via shoot bolt which are positioned at the top and bottom in the slave sash rebate.



Opening and closing is carried out via the lever on the shoot bolt.



Operating manuals of possible **access control** (fingerprint, transponder, wireless,...) are not included in this Maintenance, care and warranty booklet. These will be dealt with in special instruction manuals.

**2.4. Sun and insect protection****Aluminium window shutter**

Ensure that open window shutter sashes are correctly fixed in the wall holders. Close window shutters when storms (wind speeds over 35 mph). Otherwise occurring load can damage or destroy hardware parts. This can lead to subsequent damage.

**Open and close shutter**

In order to **open**, engage the latch of the closing lever and turn lever. Then turn shutter open, until it engages in the wall shutter catch.



In order to **close** the shutter, press down the shutter catch and turn the shutter inwards. Then turn locking lever until the turn bar lock engages by itself.



#### Operation of the hinge locking mechanism

When closing the shutter, press the hinge locking mechanism and turn shutter inwards. When opening the shutter, the hinge locking mechanism engages automatically. The shutter can be unhinged or hinged at approx. 15° opening angle.



#### Adjustment of slats

Adjustable slats are adjusted via a thumbscrew. Loosen it and move it up or down until the slats are in your desired position. After reaching this position, carefully tighten the thumbscrew again.

### Blinds

Protection from strangulation EN 13120

Buildings with ball chain driven blinds which children between 0 and 42 months have access to or can stay in such as homes, hotels, hospitals, churches, shops, schools, nurseries and public buildings have to be equipped with a "child safety device" on to the inner end (blind with ball chain). Protection from strangulation also applies if the place of use is unknown.

Protection from strangulation does not apply to buildings which children generally have no access to such as offices, factories, laboratories etc.



Child-proof version: With tear-off system of 6 kg within 5 sec. Connection with 1 ball



Not child-proof version:  
Connection with 2 balls



1. To **lift, lower** or **turn** blinds, unfasten ball chain from ball chain holder.



2. Then bring the blind into the desired position by pulling downward - as straight as possible - on the ball chain above the ball chain connector, finally re-fasten ball chain in ball chain holder.

**Insect protection**

**Pull-down flyscreen**

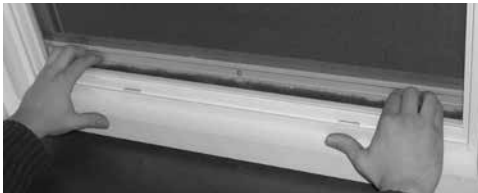

**Closing the pull-down flyscreen**

Pull screen down with both hands until it engages in the catch.

**Opening the pull-down flyscreens**

**From the inside or outside**

Push with both hands down until the catch disengages.

**Friction-fit frame**



1. Open the window. Hold the friction fit frame on the plastic clips and put into the frame clearance on the outside. Position the bottom brackets first between the window frame and the gasket.



2. Pull the friction fit frame into the frame clearance so that the top brackets can also be positioned into the window frame by moving the plastic clip up. Afterwards fold the plastic clips down.

**2.5 I-TEC VENTILATION**

**2.5.1 ventilator IV30**

**Operation**

Level 0: Stand by  
 Level 1: Whisper mode, 4-6 m³/h  
 Level 2: 8 m³/h Level 3: 23 m³/h  
 Level 4: Turbo mode (ventilation system runs for 1 hour on full load and switches back to the previously set mode automatically)

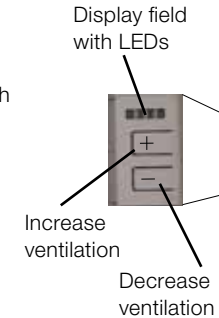

The respective operating level of the ventilation system is displayed on the display field with green LEDs.

The LED display goes out after 1 minute and only lights up with the next press of a key.

**Level 4:**

Press the + button for at least 2 seconds.

**Level 0:**

Ventilator on level 1 and press the - button for 5 seconds.

The red LED lights up when a filter change is necessary (display is time-controlled).

To quit display „change filter“: press + key and - key at the same time for at least 5 seconds.

**Illuminated LEDs**

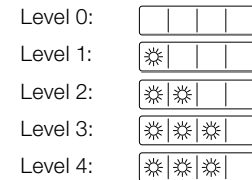

The red LED flashes if there is a defect in the device. Please call customer service.

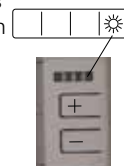

**Pressure conditions in the room when operating ventilator:**

In principle the ventilation controls work balanced and work to avoid over-pressure in the room, however the speed of the used air ventilator is slightly raised compared to the fresh air ventilator. The pressure in the room however is massively influenced by the pressure conditions in the building or the pressure/suction conditions due to wind loads.

If you would like to have an open fire place, please be in contact with your chimney sweep. For complete protection when operating open fires, an additional pressure controller might need to be installed in the room.

**Frost protection device:**

To prevent the danger of the heat exchangers icing up, the ventilation system has been equipped with a frost protection device. The electronic device continuously monitors the extracted air temperature (after the heat exchanger).

If this falls below a certain value, first the speed of the extracted air ventilator is increased and the speed of the fresh air ventilator is decreased.

If after an observation time of 10 minutes no "normal state" has been achieved, the fresh air ventilator is switched off.

If after a further 10 minutes this has not lead to a normalising of the temperature, the ventilation system is switched off completely.

Only once the temperature sensor has reached its threshold value, the ventilator will start off again automatically at its last set ventilation level.

**Emergency start-up:**

Starting up the ventilator in cold temperatures (below approx. +5 °C) will be initially prevented by the frost protection device

If you would still like to run the ventilator, please proceed as follows:

Press the – key for 10 seconds, this resets the control. Then select with the + key the required ventilation level.

If the extracted air temperature has not reached at least the threshold value after 10 minutes, the frost protection device will take over again as described above.

**Installation of add-on elements:**



If add-on elements are retro-fitted (e.g.: guiding rails), please note that drilling and screwing is not allowed in the ventilator area (shaded area)!

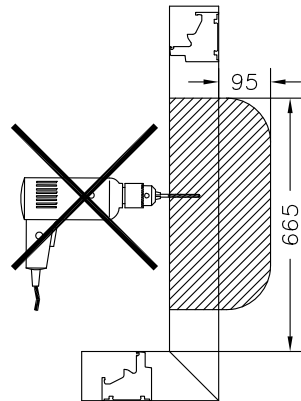

**A note on maintenance:**

For hygienic reasons, please change the filters at least 1x per year. The time-controlled LED display only serves as a reminder and does not take possible contaminated outside air into consideration. Very dirty filters will also considerably impair the desired air exchange. Autumn is an ideal time for exchanging the filters as generally air in winter is more polluted than in summer and therefore the filter would be most effective.

**Change air filter**



Firstly, switch ventilation system to stand by (level 0)! Otherwise danger of injury due to rotating fan.

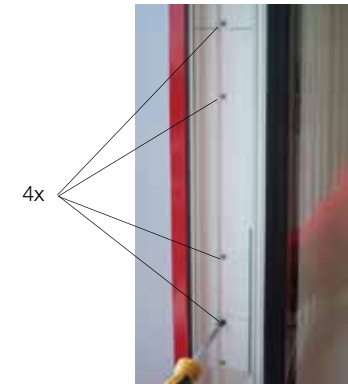

Open sash, unscrew middle cover and take cover off.



Pull the sash slightly closed and tilt the cover towards the outside when taking it off.



Take out dirty filters and put new filters back in. Put cover back on and screw on.

**Deactivate ventilation system**

If you want to deactivate the ventilation system and to close off the air inlet and outlet to avoid possible draughts, you can seal off the air channels with some foil.



Take off middle cover as when changing filters.

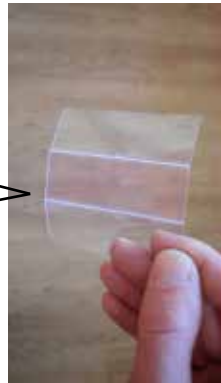

On the inside of the cover you will find two folded pieces of foil.



Unfold the pieces of foil and place them each under the filter mat.

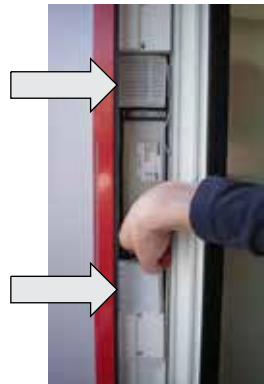

Put the filter mats on top and fasten the cover.

**2.5.2 ventilator IV40**

**Operation**

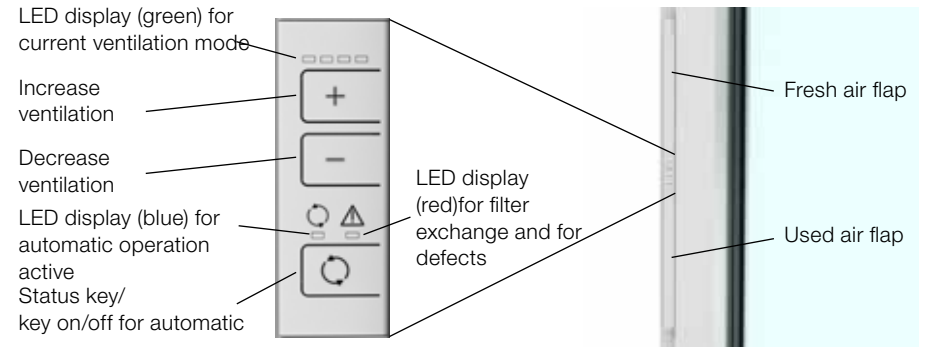

The respective ventilation mode is displayed with green LEDs in the display field.

The LED display goes out after 1 minute.

Level 1-3:  
By pressing the + or - key, the ventilation is increased or decreased by one level.

Level 0 (ventilator switched off):  
Ventilator on level 1 and press - key for 2 seconds.  
The ventilator can also be switched off by closing at least one air flap (fresh air, used air). After opening both air flaps the ventilator runs again at its previous setting.

Note:  
Even if both air flaps are closed, depending on wind load, air can be pressed into the ventilator.



LED display of ventilation levels

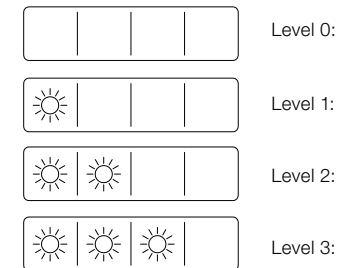

Legend:  
☀ ...LED green illuminated

## 2. OPERATION

Internorm®

### Status key / automatic On/Off:

If the LED's have gone out, by pressing the status key/automatic key, the current status can be displayed again for 1 minute.



Status key /  
Automatic key

### Turbo mode (level 4):

By pressing the + key for at least 2 seconds, the turbo mode (level 4) is activated.

Within 15 seconds you can choose the desired running time between 1 and 4 hours by pressing the + or – key.

Pressing the + key increases the running time, pressing the – key decreases the running time.

After the selection time of 15 seconds, all 4 LEDs light up green for 2 seconds and the running time can no longer be changed.

Once the running time is completed or the turbo mode has been deactivated by pressing any key, the I-tec ventilator automatically returns to the previously set ventilation level.

### Turbo mode

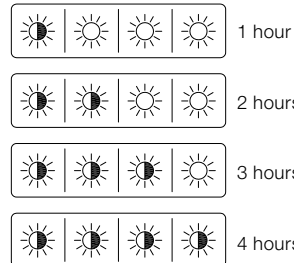

### Legend:

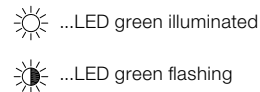

### Automatic mode:

While the operation mode is displayed, by pressing of the status key/automatic key, the automatic mode can be switched on or off (blue LED illuminated when automatic ON). Air humidity is measured in automatic mode and this the ventilator is controlled in such a way that always a healthy room climate prevails. The ventilator switches off below approx. 35% of humidity. Once the humidity rises, the ventilator switches on again. Depending on humidity levels, the corresponding ventilation level is chosen automatically.

Also the LED for automatic operation goes out after 1 minute, again - by pressing the status key, it is displayed again if the automatic operation is active.



Status key /  
Automatic key

## 2. OPERATION

Internorm®

### Night cooling:

Night cooling serves to prevent overheating of living areas during summer months.

Additionally, the fresh air ventilator or used air ventilator can be deactivate. This overrides the function of the heat exchanger and cooler outside air is blown directly into the room (night cooling fresh air) or warm room air is blown to the outside (night cooling used air). The best effect is achieved if two ventilators opposite to each other in the house are set in such a way that one ventilator is in fresh air mode and the other one in used air mode. This causes cross-ventilation in the building without the need for opening or tilting windows. If only one ventilator is available, we recommend tilting a window on the opposite side in the house, otherwise the desired effect can only be achieved partially.

### Night cooling fresh air:

With this, only the fresh air ventilator is in operation, the used air ventilator is switched off.

By simultaneous pressing of + key and status key, the night cooling fresh air is activated. Within 15 seconds, the desired ventilation level can be selected by pressing the + or the – key.

Pressing the + key increases the ventilation level, pressing the – key decreases the ventilation level.

After the selection time of 15 seconds all 4 LEDs light up green for 2 seconds and the ventilation level can no longer be changed.

Pressing any key will deactivate night cooling. The ventilator returns to its previously set ventilation level.

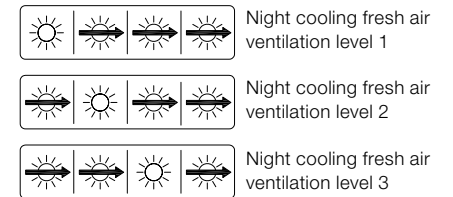

### Legend:

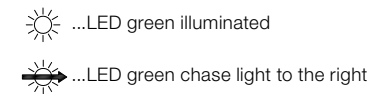

**Night cooling used air:**

With this, only the used air ventilator is in operation, the fresh air ventilator is switched off.

Within 15 seconds, the desired ventilation level can be selected by pressing the + or the – key.

Pressing the + key increases the ventilation level, pressing the – key decreases the ventilation level.

After the selection time of 15 seconds all 4 LEDs light up green for 2 seconds and the ventilation level can no longer be changed.

Pressing any key will deactivate night cooling. The ventilator returns to its previously set ventilation level.

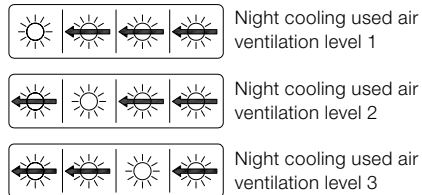

Legend:

 ...LED green illuminated

 ...LED green chase light to the left

**Switch-off automatic with automatic mode or night cooling:**

If outside temperature exceeds room temperature, ventilator automatically switches off.

Every hour, ventilator is checking temperature conditions by switching both ventilator motors on for a short time. If outside temperature is still higher than room temperature, ventilator switches off again. If outside temperature falls below room temperature, ventilator automatically returns to night cooling mode.

The temperature monitoring takes place with sensors which are built into the inside of the ventilator. The detected values for inside and outside temperature can therefore deviate from externally measured temperatures.

**Warning/defect:**

The red LED comes on if a filter change is required (display is time-controlled).

Cancel display “filter change“:  
Press the + and – key at the same time for at least 5 seconds.



The red LED flashes, if there is a defect in the appliance. If the defect has only happened for a short time, the display can be cancelled as follows:  
Press the + and – key at the same time, shortly afterwards additionally press the status key/automatic key and keep all three buttons pressed.

If the defect is displayed again after 1 minute, please call customer services.

**Pressure conditions in the room when operating ventilator:**

In principle the ventilation controls work balanced and work to avoid over-pressure in the room, however the speed of the used air ventilator is slightly raised compared to the fresh air ventilator. The pressure in the room however is massively influenced by the pressure conditions in the building or the pressure/suction conditions due to wind loads.

If you would like to have an open fire place, please be in contact with your chimney sweep. For complete protection when operating open fires, an additional pressure controller might need to be installed in the room.

**‘Show’ and ‘hide’ the wireless module:**

The I-tec ventilator can conveniently be controlled with the handsender of the I-tec blind or with the I-tec SmartWindow via mobile phone or tablet. To avoid finding the I-tec ventilator again with a new search, after it has already been listed in the handsender or Gateway, the wireless module can be ‘hidden’ via the handsender or the SmartWindow-App. This does not affect the control of the ventilator.

‘Show’ the wireless module again via the operation unit on the window:

Switch ventilator into standby mode for this. By pressing the + and the status key at the same time for a minimum of 10 seconds, all LEDs start to flash green. Press the - key briefly within 15 seconds and this shows the wireless module again for the gateway or handsender.



## 2. OPERATION

Internorm®

### Frost protection device:

To prevent the danger of the heat exchangers icing up, the ventilation system has been equipped with a frost protection device. The electronic device continuously monitors the extracted air temperature (after the heat exchanger).

If this falls below a certain value, the speed of the fresh air ventilator is decreased in levels. If there is still danger of icing up, the ventilator is switched off for 2 hours. After this the ventilator starts again automatically, checks the temperature conditions once more and starts after 10 minutes either once more with the frost protection mode or returns to normal operation.

### Functioning in cold rooms:

If the room temperature falls below +8°C (e.g. on the building site), the ventilator is switched off. Operation is still possible anytime, as by pressing the + or - key the ventilator switches on again for 10 minutes. In this time the ventilator checks the temperature conditions and either switches off again or returns to normal operation.

### Installation of add-on elements:



If add-on elements are retro-fitted (e.g.: guiding rails), please note that drilling and screwing is not allowed in the ventilator area (shaded area)!

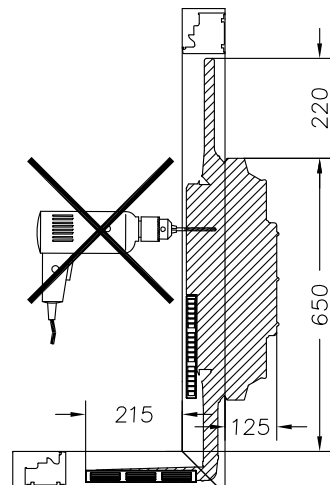

### A note on maintenance:

For hygienic reasons, please change the filters at least 1x per year. The time-controlled LED display only serves as a reminder and does not take possible contaminated outside air into consideration. Very dirty filters will also considerably impair the desired air exchange. Autumn is an ideal time for exchanging the filters as generally air in winter is more polluted than in summer and therefore the filter would be most effective.

## 2. OPERATION

Internorm®

### Exchange air filter:

When sash is open, the two filter lids for fresh and used air are visible..

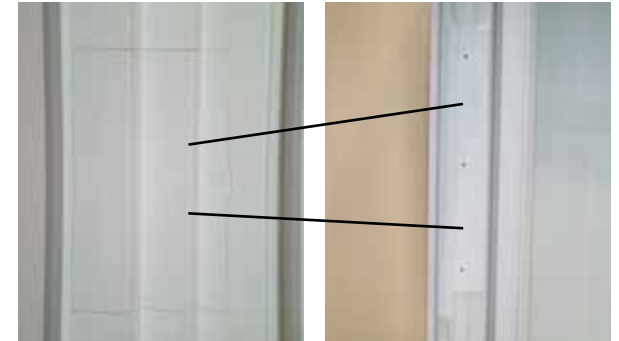

Open filter lid either with fingernail or carefully with a flat screw driver. Gently push in direction outside of frame.

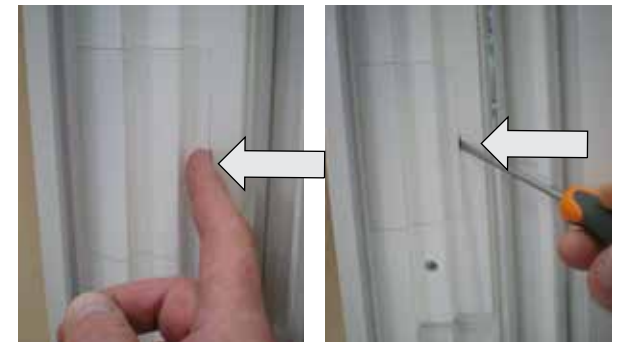

Take filter lids off and pull filter out.



Insert new filter in direction of arrow.



Watch for proper fitting of the filter!



Put filter lid back and press till it clicks in.



**Self-help if air flaps have been accidentally released.**

The air flaps can be opened without restriction about 55°. If the flaps are pushed further than that, they will come off from the air vent frame.

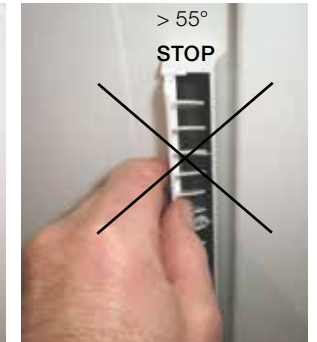

When the flap has come out, slide the flap end with the fingerlug on to the bolt and close flap.

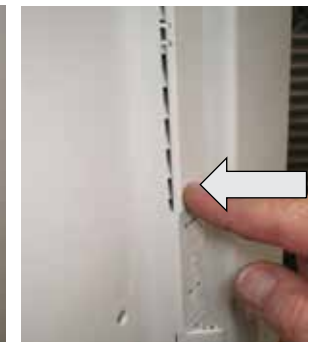

First engage the end of the flap nearer the operation unit with a bit of pressure.

Afterwards engage both middle bearing points with a bit of pressure.

Now the air flap can be operated again as usual.

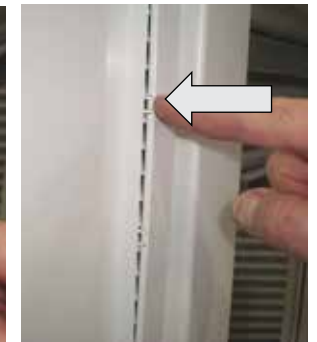

2.6. I-tec-shading



Operation

Key description:

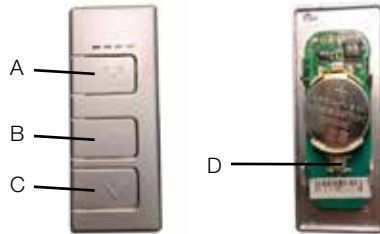
- A:  Selection key
- B:  Key Up
- C:  Key Down
- D:  Program key





To move the blind:

By pressing the Up  or Down  key briefly, the blind moves to the top or bottom end position.

By pressing the Up  or Down  key briefly, the blind can be stopped.



Adjusting the slats:

By pressing the Up  or Down  key longer, the slats can be adjusted to the desired angle.

Channel selection:

By pressing the Selection key  briefly, the desired channel can be selected. The selected channel is indicated through continuous lighting up of the LED. ■ ■ ■ ■ ■

Individual fixed position:

By pressing the Up and Down key at the same time  , the blind moves to the programmed individual position.

An overview of all functions can be found in the enclosed programming instructions.

Intensive solar irradiation on dark facade colours or window colours can lead to temperatures over 80°C in the gap between the panes. To increase the life of the batteries, the electronics are equipped with an overheating protection. With temperatures of about 70 to 80 degrees this will only allow the blind to move down and the slats to turn. Over 80 degrees no operation of the shading is possible until temperatures have cooled down again.



Excessive shade or darkening in the area of the photovoltaics module can cause reduction in energy gain.

E.g.: Balcony on top, awning, narrow town lanes etc.

As this system is based on wireless control, wireless communication and range can be affected by local circumstances.

E.g.: Stone walls, steel beams etc..

Changing the battery



First move the blind to the top!  
Open window sash at handle and attachment sash via turning connector.



Turn the black clips on the top and you can take out the blind to the bottom!



Undo the connector between battery and circuit board in order to remove the old battery.

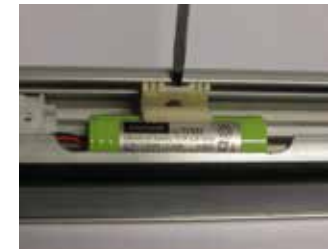

Loosen the battery clip connector and take battery out. Put new battery in, plug connector back in circuit board, watch out that the cable at the side does not touch the rotating shaft.

Changing the battery on the integrated operating unit

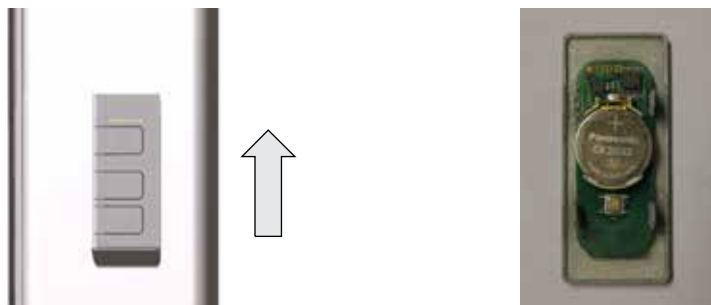

Slide open the cover of the operating unit to the top and take out the operating unit.

Take out battery from the operating unit, insert new one, put cover back on and slide it down.

Changing the battery on the hand transmitter



Push the cover at the bottom to the side to open the clip connection.

Take out old battery, insert new one and put cover back on.



Please dispose of used batteries in an environmentally friendly manner!

2.7 Opening control (wireless)

Operation

The opening control (wireless) is communicating exclusively with the Internorm-Gateway and can transmit, depending on which version was ordered, the status "sash closed and locked" and "sash tilted" or "sash closed".

To program the opening control (wireless) to the Gateway, please proceed as follows:

The batteries (2 off AAAA) are already inserted in the factory. Remove the battery cover to take out the batteries.

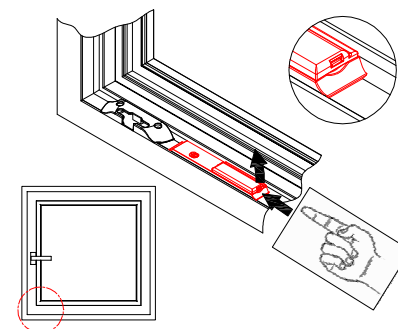

Remove batteries and wait for 10 seconds.

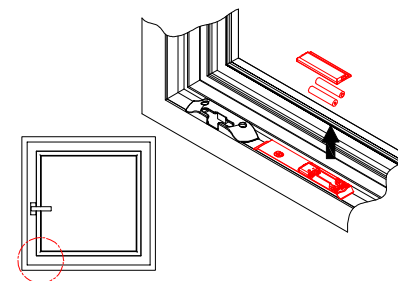

Insert batteries again. Watch for correct polarity! Put battery cover back on.

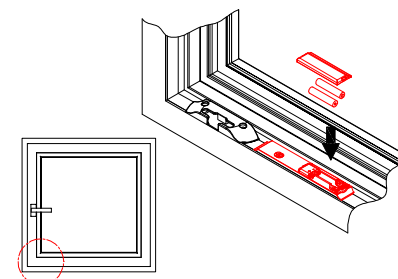

**The programming mode for the Gateway is now active for minutes.**

Repeat process for new activation of programming mode.

Possible adjustments in windows and window doors



Ensure that the adjustment ranges are only used to an extent that does not impair functionality!

**Height adjustment**

Used to raise or lower the sash.

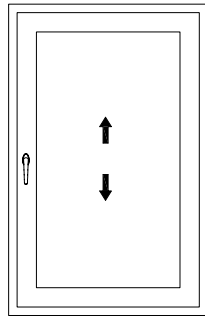

**Closing pressure adjustment**

Used to regulate gasket pressure.

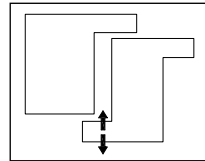

**Side adjustments**

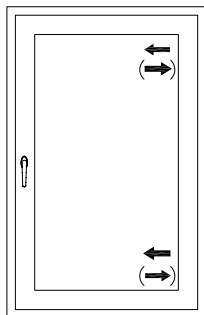

If hinged parts are adjusted in same direction, sash may be adjusted horizontally.

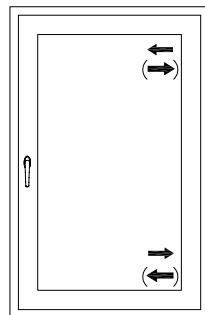

If hinges are adjusted in the opposite direction, this leads to raising or lowering of the sash on the handle side.

3. ADJUSTMENTS –  
ADJUSTMENT POSSIBILITIES

3.1. Concealed hardware

In order to prevent damage and to retain full functionality of the window, it is recommended to have all adjustment works carried out by authorised personnel.

3.1.1 VV hardware (concealed standard)

Corner / sash hinge on rectangular window (hinge side - at the bottom)

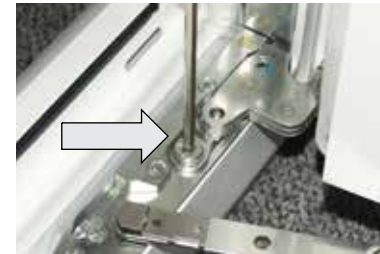

Adjust towards hinge or handle side with 4mm Allen key.



Raise or lower sash with 4mm Allen key, for heavy-duty hardware use torx T25.



Adjust closing pressure with 4mm Allen key.

### 3. ADJUSTMENTS AND ADJUSTMENT POSSIBILITIES

Internorm®

#### Stay-arm / turn hinge on rectangular window (hinge side - at the top)



Adjust towards hinge or handle side with 4mm Allen key.



For heavy-duty hardware use torx T25.

#### Pressure adjustment on locking parts



Adjust required contact pressure with fork wrench SW11. Adjustment is available in steps of 22.5°.

### 3. ADJUSTMENTS AND ADJUSTMENT POSSIBILITIES

Internorm®

#### Tilt sash



##### Vertical adjustment version a

Tilt sash. Raise or lower sash with 4mm Allen key.



##### Vertical adjustment version b

Open sash max. 90°. Raise and lower sash alternately with 4mm Allen key.



##### 1. Horizontal adjustment

Open rebate stay-arm lock, unhinge rebate stay-arm and bring sash into cleaning position.



##### 2. Horizontal adjustment

Unlock and unhinge cleaning stay-arm.  
**ATTENTION:** Sash is now unsecured and must be secured by a second person! Tilt sash no more than 90°!



Loosen fixing screw on tilt hinge with 4mm Allen key.



Turn security bolt on both tilt hinges with 5mm Allen key by 180°.

**ATTENTION:**

Sash is no longer secured against unhinging! Danger of falling!

Adjust sash horizontally and carry out all steps again in reverse order.

3.1.2 VV hardware (concealed TopStar)

Corner/sash bearing on rectangular window (hinge side bottom)

Raising and lowering of sash with SW4 Allen key (1).

Adjustment of direction hinge or drive side with SW4 Allen key (2).

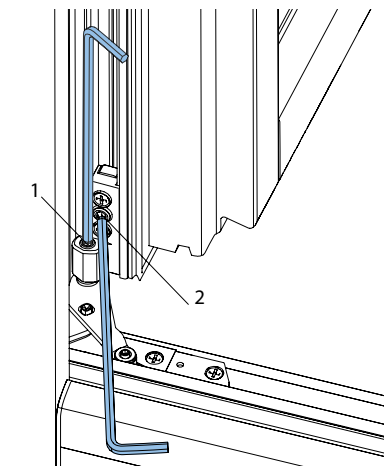

Contact pressure adjustment with fork wrench SW10.

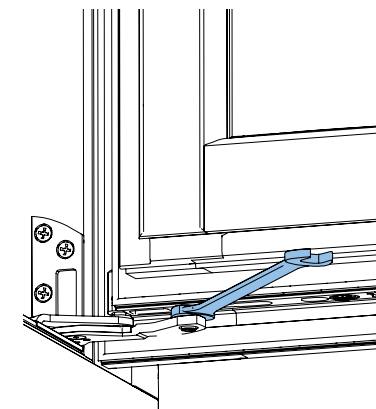

Stay-arm/turn bearing with rectangular window (hinge side top)

Adjustment in direction hinge or drive side with SW4 Allen key.

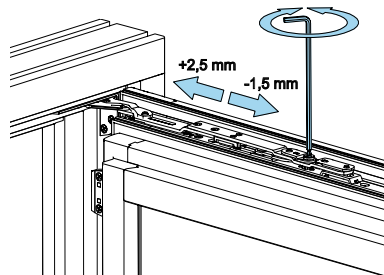

Tilt sash

**Tilt sash.** Lift and raise sash with SW4 Allen key.

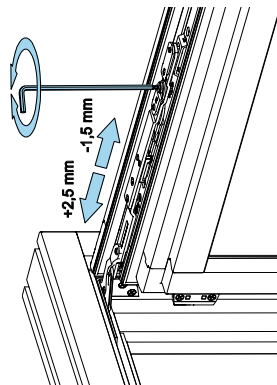

information to adjustment of contact pressure and to hinging and unhinging of rebate and cleaning stay-arms, see chapter 3.3.3 VV hardware (concealed standard).

3.1.3 I-tec locking (concealed flap locking)

Corner / sash hinge on rectangular window (hinge side - at the bottom)



Adjust towards hinge or handle side with 4mm Allen key.



Raise or lower sash with 4mm Allen key.

Stay-arm / turn hinge on rectangular window (hinge side - at the top)



Adjust towards hinge or handle side with 4mm Allen key.



Catch at doors

Adjust the catch with 3mm Allen key.



3. ADJUSTMENTS AND  
ADJUSTMENT POSSIBILITIES

Internorm®

Tilt hinge



Open rebate stay-arm lock, unhinge rebate stay-arm and bring sash into cleaning position.



Raise and lower sash with 4mm Allen key.

If the height adjusting screw cannot be accessed in the cleaning position, the cleaning stay-arm has to be unhinged additionally as well.



**ATTENTION:** Sash is now unsecured and must be secured by a second person! Tilt sash no more than 90°!



Open cleaning stay-arm lock with slot screw driver and unhinge cleaning stay-arm. **Secure sash!!**

3. ADJUSTMENTS AND  
ADJUSTMENT POSSIBILITIES

Internorm®

Maintenance of I-tec locking

Once per year all movable hardware parts have to be lubricated with acid-free oil or grease!

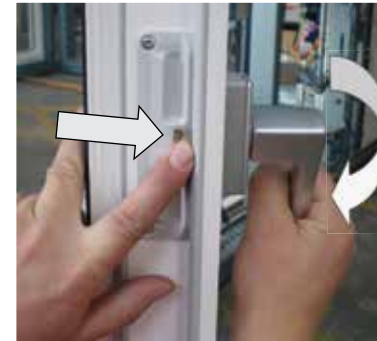

Open sash, press the rocker switch on the drive for the safety device and bring handle into locking position. This opens the locking latches.



If necessary grease sliding parts.

All hinge joints on all top and bottom hinge parts have to be greased.



1 2



3 4 5 6

3.2. Exposed hardware

For some adjustment works possible covering caps have to be removed first.

Sash hinge and corner hinge (hinge side - at the bottom)

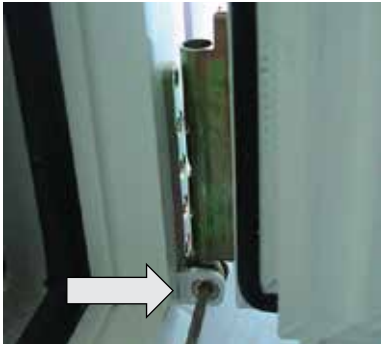

Adjust towards hinge or handle side with 4mm Allen key.



Raise or lower sash with 4mm Allen key.

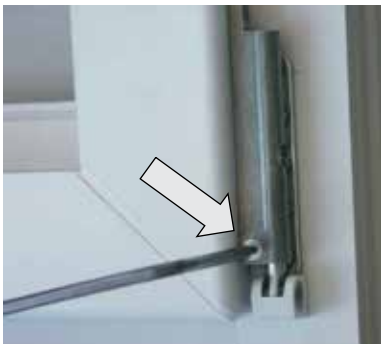

Adjustment of turn limiter with 2.5mm Allen key, if right-handed - with sash closed, if left-handed - with sash open.



Stay-arm and turn hinge on rectangular window (hinge side - at the top)

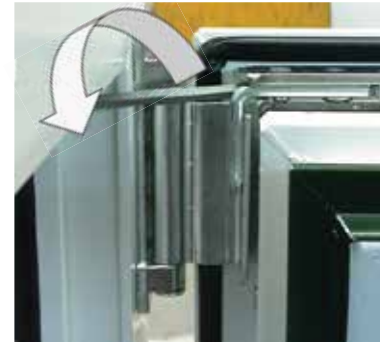

Adjust towards hinge or handle side with 4mm Allen key.

Tilt sash

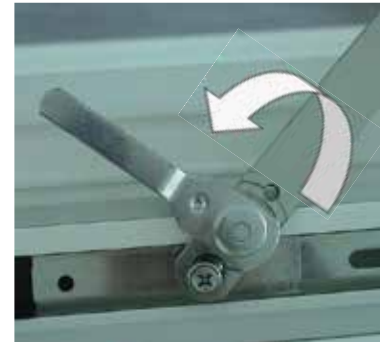

1. Vertical adjustment

Unlock rebate stay-arm and unhinge, then position sash carefully in window reveal.



2. Vertical adjustment

Unlock cleaning stay-arm and unhinge. **ATTENTION:** Sash is now unsecured and has to be secured by a second person!

### 3. ADJUSTMENTS AND ADJUSTMENT POSSIBILITIES

Internorm®

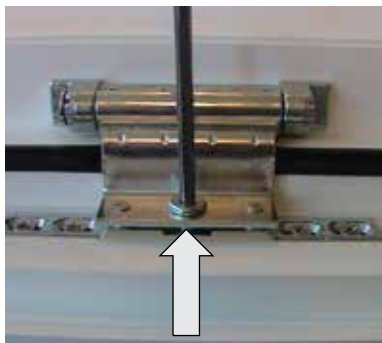

Raise and lower sash with 4mm Allen key.

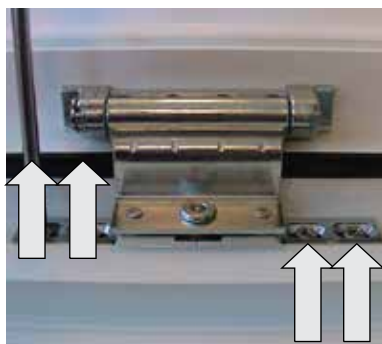

#### Horizontal adjustment

Unhinge rebate stay-arm and cleaning stay-arm, as described above. Loosen screws with screwdriver, adjust sash horizontally and tighten screws again. Hinge the cleaning and rebate stay-arm again and lock.

### 3. ADJUSTMENTS AND ADJUSTMENT POSSIBILITIES

Internorm®

#### 3.3. Further hardware versions

##### Fanlight hardware

##### Closing pressure adjustment

Remove covering cap towards the front. Loosen screw at bottom with 4mm Allen key, adjust pressure with SW14 flat spanner and tighten screw again.

Measures to adjust sashes, as described in previous chapters.

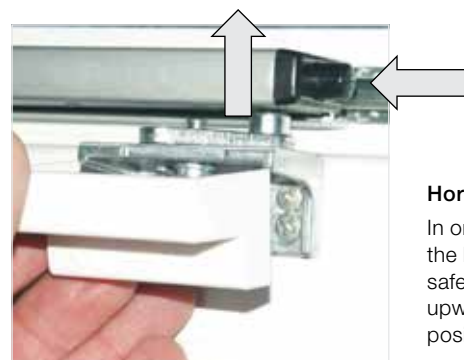
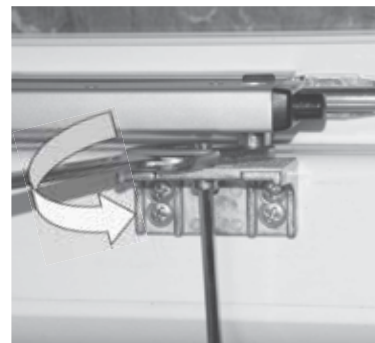

##### Horizontal and vertical adjustment

In order to be able to separate the stay-arm from the bracket, first tilt the sash. Then press the safety knob on the stay-arm, pull stay-arm upwards off the bolt and bring sash in secure position.



To be able to bring sash into cleaning position (open it completely), undo locking mechanism on side-mounted safety stay-arms.

Further measures for sash adjustment, as described in previous chapters (tilt sash).

### 3. ADJUSTMENTS AND ADJUSTMENT POSSIBILITIES

Internorm®

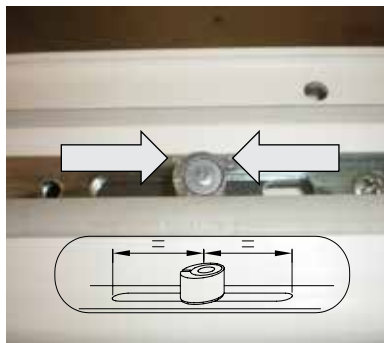

If a bolt of the fanlight hardware engages with the sash hardware, it is absolutely important to centre the locking bolt of the sash hardware which might have been slid to the side by accident, otherwise the sash cannot be closed.

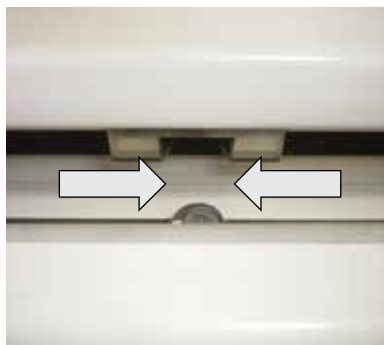

When closing the sash, the bolt of the fanlight hardware has to engage with the locking bolt again.

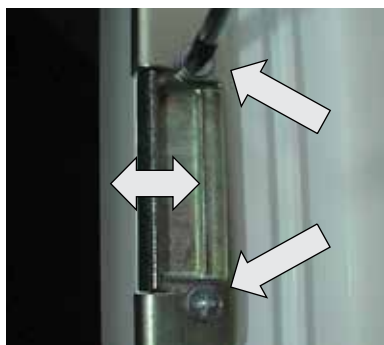

#### Multi-point lock and latch/spring-bolt lock

##### Closing pressure adjustment

Slightly loosen screws with screwdriver. Move locking plate insert and tighten screws again.

Measures for sash adjustments, as described in previous chapters.

### 3. ADJUSTMENTS AND ADJUSTMENT POSSIBILITIES

Internorm®

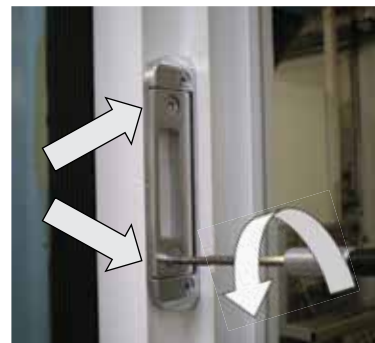

#### Side entrance door

##### Closing pressure adjustment for latch:

To adjust the closing pressure, adjust the eccentric bolts of the locking element with 4mm Allen key.



##### Closing pressure adjustment for locking bolt:

To adjust the closing pressure, adjust the eccentric bolts of the drive with a torx T15.

### 3. ADJUSTMENTS AND ADJUSTMENT POSSIBILITIES

Internorm®



#### Three-dimensionally adjustable turn hinges

##### Height adjustment

Loosen safety screw for height adjustment with 4mm Allen key. This is only accessible with the sash open.

Then adjust height adjustment screw from below with 4mm Allen key.



Before tightening the safety screw ensure that it attaches to the flattened side of the height adjustment screw, otherwise the thread will get damaged.



##### Side adjustment

The screws for side adjustment are accessible from the reveal (soffit) side when sash is closed and from the rebate side when sash is open.

**ATTENTION:** The screw position indicated by the arrow is fixed to the centre part of the hinge. In order to avoid damage on the thread loosen the other screw before adjustment!

### 3. ADJUSTMENTS AND ADJUSTMENT POSSIBILITIES

Internorm®



Side adjustment is carried out by adjusting both screws on the centre part of the turn hinge with a 5mm Allen key.

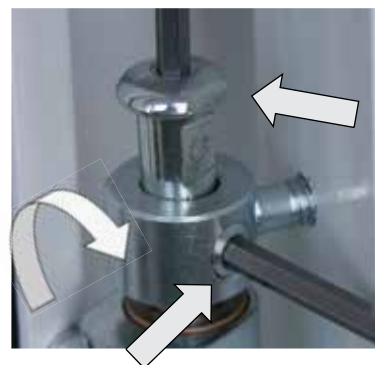

##### Closing pressure adjustment

Loosen peg with 4mm Allen key. This is only accessible when sash is open. Pull peg upwards and unhinge sash. Turn parts remaining on the door frame inwards or outwards.

**ATTENTION:** When re-fitting the sash, insert peg so that flattened side faces the safety mechanism.

##### General advice:

The adjustment screws are only accessible if first both outer covering caps have been removed upwards or downwards and the central covering cap has been removed towards the front.



**3 sash windows without transom,  
centre sash**

**Height adjustment**

First open side sashes. Adjustment is carried out on the support bar of the centre sash with 4mm Allen key.

Adjust side sashes as described in previous chapters.

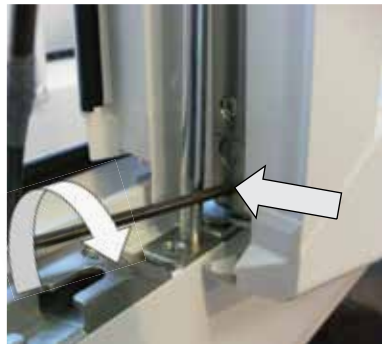

**Side adjustment corner hinge**

Open centre sash so far that Allen screw is no longer covered by support bar. Adjust with 2.5mm Allen key.



**Side adjustment of turn hinge**

Open centre sash. Adjust with 4mm Allen key.

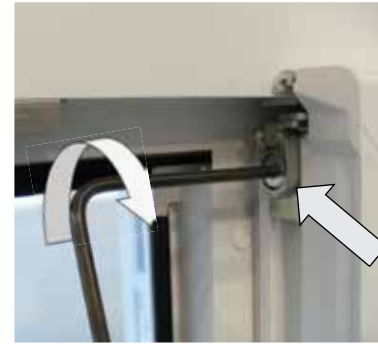

**Closing pressure adjustment in turn hinge**

Adjust with 4mm Allen key.

Adjust side sashes as described in previous chapters.

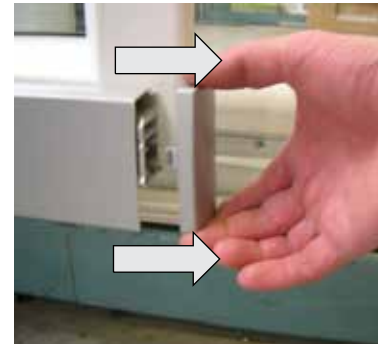

**Sliding windows**

**Height adjustment**

Pull covering cap off sideways from the runner.

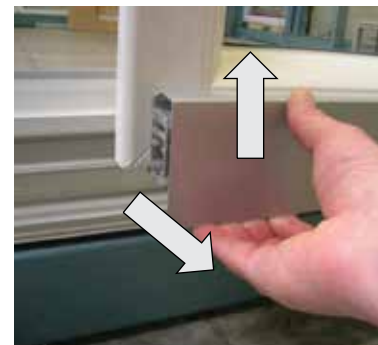

Remove cover profile from the holding clips at the bottom and lift off towards the top.

### 3. ADJUSTMENTS AND ADJUSTMENT POSSIBILITIES

Internorm®

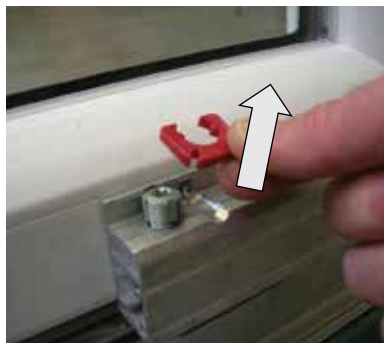

Take off turn stop from height adjustment screw.

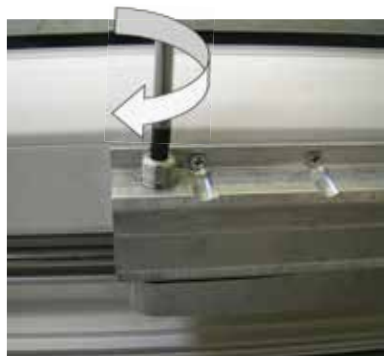

Adjust sash with torx T40.

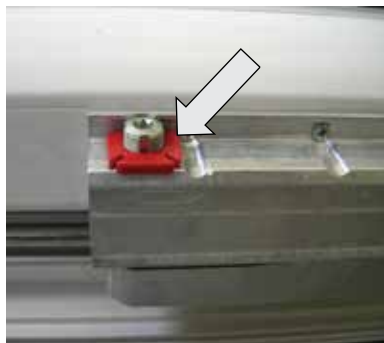

Put turn stop back on.

Attach cover profile again and press on tightly at the bottom. Put side cover caps back on.

### 3. ADJUSTMENTS AND ADJUSTMENT POSSIBILITIES

Internorm®

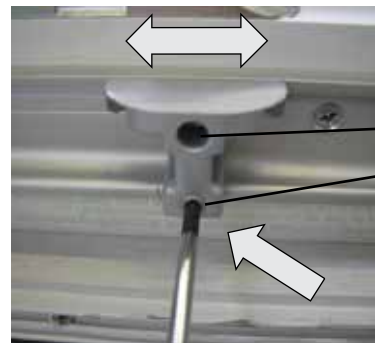

3-4 Nm

1-2 Nm

**Bottom stopper for sliding direction "CLOSED"**  
Loosen screw with torx T25, move control block to the side and tighten screw again (max. 3 Nm).



**Top stopper for sliding direction "OPEN"**

Loosen screw with torx T25, move buffer to the side and tighten screw again (max. 3 Nm)  
Loosen screw with Torx T25, slide stopper to the side and tighten screws again (3-4 Nm).

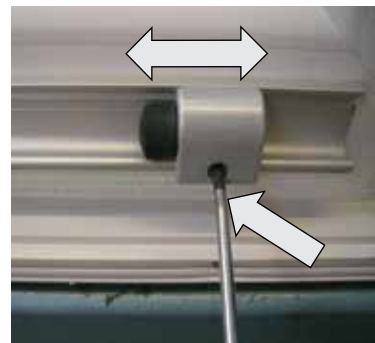

**Bottom stopper for sliding direction "OPEN"**

Loosen screw with Torx T25 lockern, move buffer to the side and tighten screw again (2-3 Nm).

### 3. ADJUSTMENTS AND ADJUSTMENT POSSIBILITIES

Internorm®

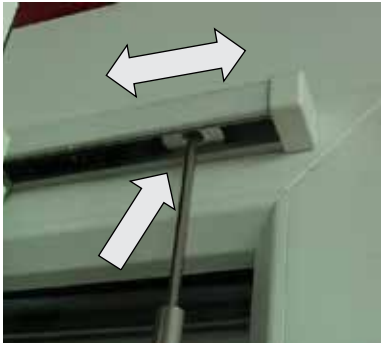

#### Top stopper sliding direction "OPEN"

Additionally to the running rail also for the buffer in the guide rail. Loosen screw with Torx T25, move buffer to the side and tighten screw again (3-4 Nm).



The stopper buffers serve only to limit the opening and must not be used to stop the sliding sash abruptly!

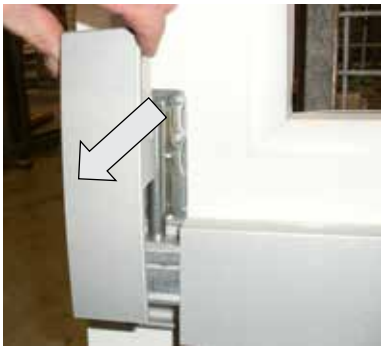

#### Sliding door

All adjustment possibilities are the same as with the sliding window.

#### Height adjustment

Remove covering caps to the front. Remove cover profile and carry out height adjustment as described under "Sliding windows".

#### Maintenance of sliding windows and sliding doors

Once per year all movable hardware parts should be cleaned and greased with acid-free oil or grease!

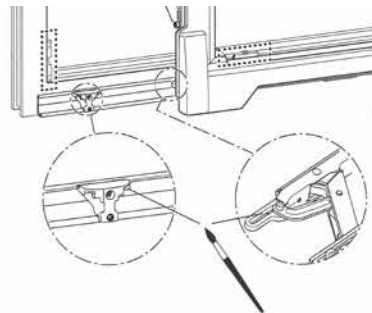

Pay also special attention to the control blocks and to the engaging mechanism at the top and bottom.

### 3. ADJUSTMENTS AND ADJUSTMENT POSSIBILITIES

Internorm®



#### 3.4. Entrance doors

##### Aluminium entrance doors

Adjusting of the latch locking part applies also to:

- AT piece
- Electric door opener (ETÖ)
- Mechanical day latch (MTOE)



It controls the closing pressure from the lock side for latch/spring bolt locks and multi-point locks.

1. Remove both fixing screws.
2. Adjust latch locking part (adjustment via raster).
3. Put fixing screws back in.



**Locking cases for bolt-hookbolt  
for multi-point locking types MV, EV-C and EV-E**

Controls the locksided contact pressure

**1.) AT200**

Adjust both eccentric screws with SW4 Allen key.  
The locking case changes its position and therefore, the contact pressure changes too.

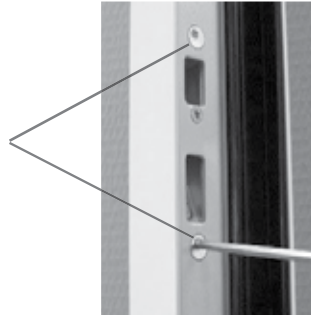

**2.) AT310, AT400, AT410**

For adjusting, first loosen the 3 fixing screws.  
Then carry out adjustment via the two eccentric screws.  
Position is shown by marking point on the screws.  
Afterwards tighten fixing screws.

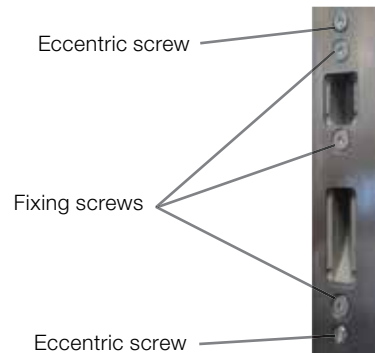

**Locking cases for hookbolt  
for multi-point locking types MV-AM and EE**

Contact pressure **cannot** be adjusted via the locking cases.

The adjustment is carried out in such a way that the hookbolt after closing of the door sash can engage freely - preferably centered.  
Test: Apply strong counter-pressure in the area of the locking cases  
--> Door sash should not show much of a positioning distance!

The adjusting process is identical to  
"Locking cases for bolt-hookbolt with AT310, AT400, AT410"



**Additional catch**

With this part the hold for the door sash can be adjusted, if it is not fixed through the lock latch:

- Electric door opener (ETÖ) in unlocking position
- Mechanical day latch (MTOE) in unlocking position
- Latch retracted (manual or electrically)
- Latch does not exist (bolt lock) or fixed in retracted position.

The catch peg is installed on the striking bead (frameside),  
the counterpart where it engages is installed on the lock flying mullion.

**Adjusting:**

To adjust the torque: use a small slotted screw driver and adjust on the protrusion of the catch peg which is spring-operated.

Catch peg further out: larger torque

Catch peg further in: smaller torque

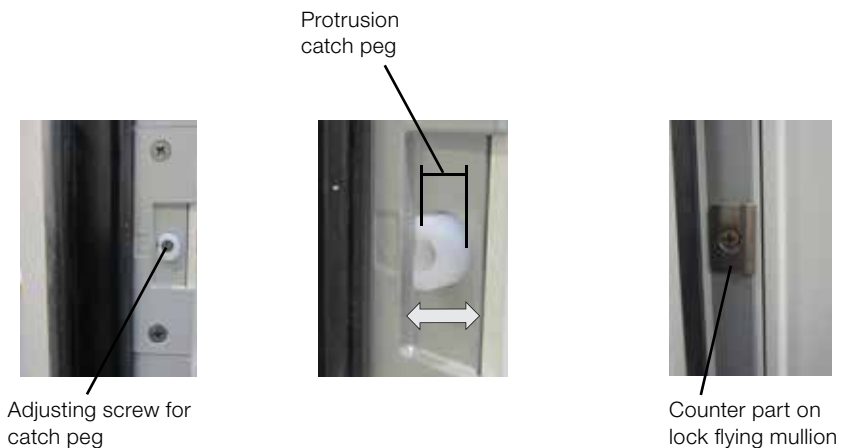

### 3. ADJUSTMENTS AND ADJUSTMENT POSSIBILITIES

Internorm®

#### Available adjustments for door hinges

Ensure that the adjustment ranges are only used to an extent that does not impair functionality of the door!



Please note especially with possible hinge safety mechanism → “tension danger“

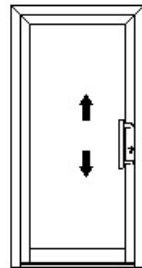

#### Height adjustment

Used to raise or lower the door sash.

Is carried out in such a way that the weight of the door sash is evenly distributed between all hinges or washers.

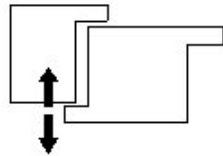

#### Contact pressure adjustment

Used to regulate how far the sash projects and therefore, adjusts the pressure placed on gaskets in the hinge area.

#### Side adjustment

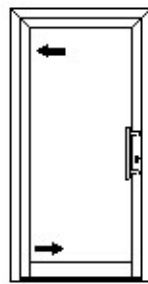
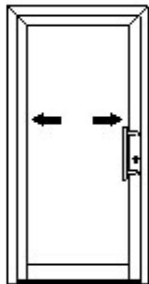

If all hinges are adjusted in the same direction, the rebate clearance (distance from lock mullion to locking plate) can be regulated.

If the hinges are adjusted in opposite directions, this leads to raising or lowering of the door sash on the handle side.

### 3. ADJUSTMENTS AND ADJUSTMENT POSSIBILITIES

Internorm®

#### Adjustment procedures for door hinges in aluminium entrance doors

All adjustments have to be carried out with a 4mm Allen key!



When adjusting three hinges, the centre hinge has to be adjusted in such a way that no tension is created!

**Process:** Remove axle bolt of centre hinge. Adjust door sash with top and bottom hinge. Adjust centre hinge so that the axle bolt can be slid back in without applying force!

#### Height adjustment (-2/+3 mm)



Remove lower cover caps.



Loosen fixing screw.



Bring adjustable support to desired height by turning to the left or to the right.



When attaching, always use the milled surface of the adjustable support!

### 3. ADJUSTMENTS AND ADJUSTMENT POSSIBILITIES

Internorm®



Adjust contact pressure (-1/+3 mm)

Remove UPVC cover.



Loosen both tension screws completely.

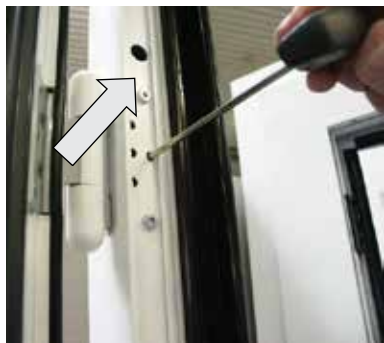

Adjust contact pressure in such a way that the gasket in the hinge area is not exposed to too much pressure (sash overlap 14-15mm).

Tighten both tension screws again.

Attach UPVC cover again.

### 3. ADJUSTMENTS AND ADJUSTMENT POSSIBILITIES

Internorm®

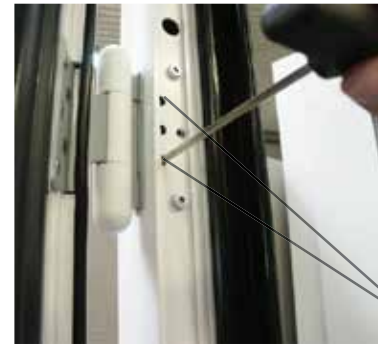

Side adjustment (+/-2 mm)

Loosen both tension screws as far as possible.

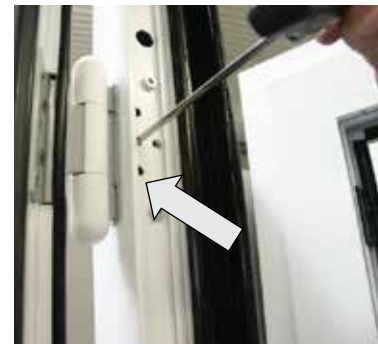

Carry out adjustment, ensure sufficient distance between lock mullion and locking plate (3-4 mm).

Tighten both tension screws again.

Attach UPVC cover again.

### 3. ADJUSTMENTS AND ADJUSTMENT POSSIBILITIES

Internorm®

#### Adjustment process - Concealed door hinge with aluminium entrance doors

The following tools are required for the adjustments:

- Ring spanner no. 13
- Special lift tool (part no.: 34588)
- 25 Torx L-key ( up until 2015 - Allan key No. 5)
- Torx key 27

With three hinges the middle hinge needs to be adjusted in such a way that no tension is created!

**Three dimensionally adjustable:** All adjustments can be carried out with mounted sash.

#### Height adjustment

Remove the hinge covers (slide towards the top or bottom and pull off).

Loosen the top 3 screws on all hinges on hinge-side with TX27.

Put the lift tool with the long side into the recess of the top hinge and loosen the rest of the screws. Lever the door sash into required position and tighten the screws from the top hinge. Afterwards lightly press against the bottom hinges and tighten.

Adjustment range: -2mm / +4mm

#### Contact pressure

Loosen both hexagonal screws of the hinge and position the hinge protrusion via the short side of the lifting tool.

Afterwards tighten the screws again. Adjustment range: +/- 1.5mm

#### Side adjustment

Adjust screws with L-key TX25 on hinge pocket as required.

Marking on hinge strap is zero position. Adjustment range: +/- 4mm



### 3. ADJUSTMENTS AND ADJUSTMENT POSSIBILITIES

Internorm®

#### Timber/aluminium entrance doors

#### Adjusting the latch closing piece (AT piece)

Regulates the lock-sided contact pressure.

1. Loosen both fixing screws.
2. Adjust latch closing piece (interlocking).
3. Tighten fixings screws again.



#### Adjust bottom and top contact pressure and correct warping on lock side

In the outer rebate area (overlap) on the lock side, there is a tension rod which can be used to correct warping in the door leaf of up to 4mm in both directions.

1. Remove cover cap.
2. Adjust the tension rod with an SW6 Allen key. By turning clockwise the rod is tensioned and the sash ends are bent towards the inside, by turning anti-clockwise the rod is lengthened and the sash ends are bent towards the outside.  
**ATTENTION: Do not exceed a torque of max. 35Nm! Danger to damage the door leaf.**



3. Put cover cap back on.

### 3. ADJUSTMENTS AND ADJUSTMENT POSSIBILITIES

Internorm®

#### Adjustment process for door hinges in timber/alu entrance doors with exposed hinges

All adjustments to be carried out with a 4mm Allen key!



Adjust the centre hinge in such a way that no tension is created!

#### Height adjustment (-2/+3 mm)



Remove bottom cover caps.



Loosen fixing screw.



Bring adjustable support to desired height  
by turning to the left or to the right and  
correct the other hinges too.



When attaching, always use the milled surface  
of the adjustable support!

### 3. ADJUSTMENTS AND ADJUSTMENT POSSIBILITIES

Internorm®



#### Contact pressure and side adjustment

On rare occasions side adjustments or adjustments  
to the contact pressure of a sash or the gaskets are  
necessary. Unhinging the door sash is necessary.

#### Unhinge door sash

1. Loosen fixing screw for hinge bolts (top Allen  
screw) on all hinges.



2. Press hinge bolt out from underneath with a  
4mm Allen key . Start at the bottom hinge. Unhinge  
door sash and put aside.



Be careful when lifting!  
Element weights over 100 KG possible!

3. Put the unhinged door sash carefully on to a  
pressure-resistant, soft surface (e.g. polystyrene  
from packaging) to avoid damage!  
When leaning it watch for secure standing and also  
use some padding toward e.g. a wall!



#### Adjust contact pressure

To change the contact pressure of the door sash  
on the hinge side, the hinge parts on the frame  
are adjusted when turning. Ensure to adjust the  
hinges evenly, otherwise the bolts will be subjected  
to tension and high wear and tear and creaking  
sounds will result. Both hinge parts always need  
to be turned full 360° turns inwards or outwards,  
otherwise they will be positioned wrongly.

### 3. ADJUSTMENTS AND ADJUSTMENT POSSIBILITIES

Internorm®



#### Side adjustment

To carry out side adjustments to the door sash, the hinge parts of the sash need to be turned inwards or outwards with a screwdriver or similar. Through this the position of the door sash is moved to the side. Ensure to adjust the hinges evenly, otherwise the bolts will be subjected to tension and high wear and tear and creaking sounds will result.



#### Hinge door sash

Bring door sash into position and insert hinge bolts again at the bottom, top and centre. It is best to begin with the bottom hinge bolt, then insert the top and the centre one tension-free.



When inserting the hinge bolt ensure the correct orientation. The flattened part needs to be in the area of the Allen screw.

Tighten all Allen screws again and attach cover caps.

### 3. ADJUSTMENTS AND ADJUSTMENT POSSIBILITIES

Internorm®

#### Adjustment process for door hinges in timber/alu entrance doors with concealed hinges

All adjustments to be carried out with a torx T20 or a 4mm Allen key!



Adjust the centre hinge in such a way that no tension is created! The door panel does not need to be unhinged for adjustments!

#### Mount door panel



The fixing screws in unhinged delivered sashes are screwed into the frame, remove these.



Bring door hinges into a 90° position and lift sash to frame. Attention - high element weights!



Slide hinges without cross threading into the retaining pockets and fasten each hinge for the moment with a fixing screw.



Use the remaining three fixing screws for each hinge.

### 3. ADJUSTMENTS AND ADJUSTMENT POSSIBILITIES

Internorm®



#### Height adjustment

The frame parts of the hinges at the back are equipped with a tooth system. If all fixing screws (4 pieces per hinge) are loosened far enough with a torx, T20 the sash can be adjusted in the height. Put door at desired height and fasten all fixing screws. Do not subject the hinges to tension to avoid creaking sounds and high wear and tear.



#### Adjust contact pressure

If the fixing screws (4 pieces per hinge) are only loosened slightly, the contact pressure on the hinge side of the sash can be increased or decreased on the height adjusted toothing system. Loosen the screws completely on the centre hinge and carry out the desired adjustments on the top and bottom hinge. Tighten all fixing screws again.



#### Side adjustment

To adapt the gap between frame and sash, the hinge can be adjusted with a 4mm Allen key. For this no fixing screws need to be loosened. Two screws per hinge need to be adjusted. Alternate screws to avoid tension on the hinges.

### 3. ADJUSTMENTS AND ADJUSTMENT POSSIBILITIES

Internorm®

#### To put lever on and take lever off (AT400)

##### Hoppe lever sets

The new generation of Hoppe lever sets is fitted via an integrated clamping system on the square lever pin.



#### To put lever on:

Put cover plate in place and slide lever on to pin until it sits tightly. Lever stays in place via preloaded metal spring on lever pin.



#### To take lever off:

1. Insert supplied special tool fully into side hole at a slight angle to the cover plate.



2. Turn special tool by about 90° to loosen clamping system.



3. Pull lever off the pin.

### 3. ADJUSTMENTS AND ADJUSTMENT POSSIBILITIES

Internorm®

#### Lever sets VD20, 21 and 22

The square lever pin of the new Valli lever set generation engages via an integrated spring clamping system with the sub-structure of the cover plate.

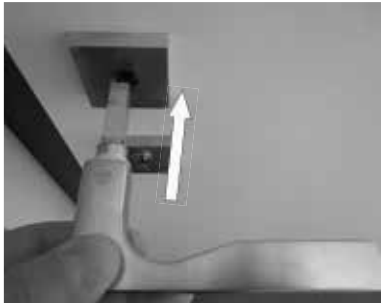

To fit lever:  
Put cover plate in place and insert lever incl. pin into cover plate opening until it engages. Lever stays in place via preloaded spring system.



To take lever off:  
1. Insert supplied special tool from below into cover plate opening.



2. Insert special tool completely. Tool engages, clamping system is loosened.



3. Remove lever incl. pin.

### 3. ADJUSTMENTS AND ADJUSTMENT POSSIBILITIES

Internorm®

#### Lever set VD20 (from week 25/2015 on)

Fitting of lever is carried out via "square" screwed cover plate. (Same sub-structure as with VD10 to VD16.)

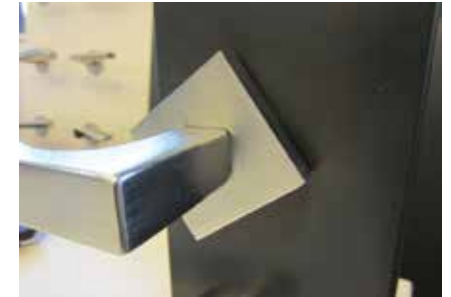

Lever cover plate is screwed on to sub-structure. Clamp function via an O-ring. A flange of 0.4mm prevents scratching of surface when cover plate is turned. (visible gap after tightening)

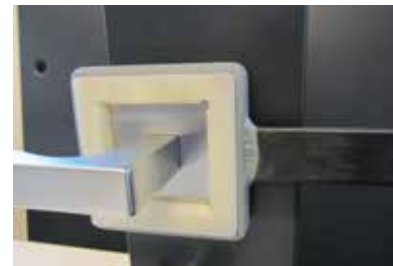

Tightening or adjusting of screw cover plate via special tool.

Drag-direction of cover plate can vary after fitting.

Screw cover plate can be loosened with pliers without any problems. Protect surface of cover plate! (Picture: UPVC jaws,...) With lever/lever undo Allen screw first.







3.5. Available adjustments for  
window shutters

**Adjustment of reveal (soffit) depth**

Reveal depth is adjusted via the hinge for reveal depth of 60 - 230 mm.



**Side adjustment (hanging of window shutters)**

Side adjustment is carried out via the hinge casings 1.5 and 3mm. Side adjustment via the spindle is only possible with reveal depth 190 - 230 mm.



**Adjustment of hinge stabiliser**

The adjustment screw has to be used to press the window shutter against the stopper buffer/wall, then the clamping screw at the top has to be tightened.



3.6. Insect protection

**Sliding frame**

1. For hinging, press the sliding frame so far upwards into the top sliding rail, until the sliding frame can be positioned into the lower sliding rail.



2. Then push the fixing part up and attach it with screws on both sides.



**Turn frame**

Before unhinging, lift the pins and remove them, then the sash can be taken off towards the front.

## 4. CLEANING, CARE AND MAINTENANCE

Internorm products are low-maintenance, easy to clean and to care for. Regular maintenance conserves value and extends the life span of windows and doors. In Austria these necessary measures are documented in the ÖNORM B 5305. This ÖNORM contains criteria to assess the state of a window as well as details and specifications concerning the implementation and instigation of maintenance.

If you adhere to the following cleaning, care and maintenance tips, you will be able to enjoy your Internorm products for a long time. In order to retain an immaculate surface, smooth-running hardware and well closing gaskets, please take note of the following care tips.

### 4.1. General information

Do not use cleaning products of unknown composition. If you are uncertain about the effects of a cleaning agent, test it on an inconspicuous, concealed part.

Please be aware that cleaning agents which cause surprising cleaning results without any special effort might often lead to long term damages.

Outside surfaces are not only exposed to weather, but also to the increased effects of smoke, industrial fumes and aggressive flying dust. Deposits of these substances combined with rain or condensation can impair surfaces and alter the decorative appearance. We recommend regular cleaning of the outside surfaces, depending on the degree of staining, in order to prevent long term settling of deposits. The sooner stains are removed from the surface, the easier their cleaning will be.



Micro fibre cloths contain substances and fibre parts which can destroy surfaces of glass, profiles and gaskets. Micro fibre cloths are therefore unsuitable for cleaning windows.

### 4.2. Hardware

All hardware parts are to be checked regularly for tight fitting and for wear and tear. If necessary, fixing screws need to be tightened or faulty parts need to be replaced by authorised personnel.

Furthermore, all gliding parts and movable hardware parts have to be greased once per year (acid free grease or oil). Hardware should only come in contact with those care and cleaning agents that do not impede the corrosion protection of the hardware parts.



Particular care must be taken when cleaning electronic hardware parts (as e.g. the window control or the plug connection between sash and frame with electric blinds). These parts need, especially during the construction period, but also during regular use of the window, to be protected of soiling and need to be kept clean to avoid disruptions in signal transmission.

With the I-tec locking the corner drives are additionally secured with a pin (grub screw) which lies under the middle gasket. Due to the alternating load when locking the sash this pin can come out through the middle gasket and needs to be screwed in flush to the bottom of the gasket groove using a SW2.5 Allen key. Otherwise the window frame might get damaged.



### 4.3. Cleaning tips for glass surfaces/ glass joints/glass corners

Dirty glass surfaces/glass joints/glass corners can be cleaned wet with water, sponge, cloth etc.

Common glass cleaners without scouring agents may be added to the water. Persistent stains such as paints or tar droplets should be removed with methylated spirits, acetone or petroleum ether. The glass surface should then be cleaned wet again.

Metallic and abrasive items (e.g. razor blades, steel wool, cleaning fleeces ...) must not be used!

## 4. CLEANING, CARE AND MAINTENANCE

Internorm®



Do not use alkaline cleaning lye, acids or cleaning agents containing fluoride to clean the glass surface.



Protect the glass surface with suitable cover foils from

- plaster splatters, cement, untreated concrete surfaces, fibre cement boards
- flying sparks or welding beads from angle grinders
- acidic facade stone cleaners.

### 4.4. Gaskets

All gasket profiles have to be cleaned and greased at least once per year to retain functionality. We recommend the care product for gaskets. This care product for gaskets retains the pliability of the gasket and prevents it from becoming brittle prematurely. Please ensure the gasket profiles are not damaged and do not come into contact with solvents.

Generally gaskets should only be cleaned with water and possibly a little drop of dishwashing liquid.



#### Permitted cleaning agents

- Alkaline cleaning agents (soapy solutions)
- Mixtures of water and alcohol

However, concentration, exposure time and ambient temperature play an important role. It could damage the material if the concentration of the cleaner is too high.

#### Prohibited cleaning agents

- Cleaners containing chlorine or cleaners with peroxides can damage the material over a longer period of time or it could lead to discolouration.
- Oils, greases, oil and grease containing substances and petrol can lead to a cracked and unsightly appearance.

## 4. CLEANING, CARE AND MAINTENANCE

Internorm®

### 4.5. UPVC surfaces

Two sets of Internorm care products are available for cleaning UPVC surfaces. One cleaning agent is especially suitable for hard UPVC surfaces and the other one for designer surfaces. Especially avoid aggressive and dissolving cleaning agents and avoid direct sunlight during cleaning on the areas which need to be cleaned.



Intensivreiniger Decorreiniger

### 4.6. Timber surfaces for timber/aluminium elements

We recommend using mild cleaning products, such as diluted washing-up liquid or soapy water, to clean inside timber surfaces. As timber surfaces on the inside are not exposed to weather (wear through rain and sunlight), coating is not necessary.

Avoid scouring, acidic and solvent cleaning products. Only use soft cleaning cloths to avoid scratching the paint surface.

Window cleaners contain small amounts of alcohol and ammonium chloride. These products are well-suited to clean glass panes, as well as timber frame profiles. Dry the timber profile thoroughly after cleaning with a dry, soft cloth, as alcohol applied to the paint surface for too long, can dissolve it.

### 4.7. Anodised or powder coated aluminium surfaces

Anodising and powder coating are considered refinements of exterior aluminium surfaces which are especially durable and decorative. In order to retain the decorative appearance of these construction parts for decades and to reduce corrosion impact, the surfaces need to be looked after at least twice per year with adequate cleaning and surface conservation products.

Depending on the degree of staining (strong stains) care and cleaning intervals should be shortened accordingly. In the outsourced cleaning and care of buildings,

processes according to the current quality guidelines for facade cleaning (GRM) are necessary.

#### 4.7.1. Requirements and process for cleaning aluminium surfaces

##### Object conditions

Do not clean surfaces in direct sunlight. The surface temperature must not exceed 25° C. Use suitable cloths for cleaning, which do not scratch the surface. Refrain from tough scrubbing.

##### Pre-cleaning

Before applying special cleaning or conserving products, existing stains should be removed in a pre-cleaning process. Use only clean water for this, possibly with small amounts of neutral cleaning agents (only pH neutral cleaning agents with a pH value between 5 and 8) e.g. washing-up liquid in normal concentration. These cleaning products should not be warmer than 25° C. Do not use steam cleaners.

##### Conservation

Use an Eloxal Polish (polish for anodised surfaces) or a Powder Polish Cleaner for stronger staining, which can serve as conservation at the same time. It forms a film on the surface of anodised or coated aluminium parts and thereby repels dirt and water for a longer time. This type of conservation however, needs to be renewed from time to time.

**Eloxal Clean for anodised** aluminium surfaces

**Powder Clean for powder coated** aluminium surfaces

These general cleaning products should only be used after a successful pre-cleaning process.

#### 4.7.2. Cleaner for anodised surfaces

When cleaning very dirty anodised surfaces, do not use scratching or scouring products. Persistent stains such as tar, laquer or similar compounds can also be removed with solvents, e.g. benzine or cellulose thinner (only for local application and with corresponding subsequent treatment). Observe the respective safety and handling instructions for each product. Gaskets or painted surfaces must not come in contact with these products.

#### 4.7.2.1 Conservation agent for anodised surfaces

##### Eloxal Polish Cleaner

This cleaning and conservation agent is a care product on emulsion basis.

##### Application range

The Eloxal Polish Cleaner and Conservation agent is well suited for stained anodised aluminium surfaces, which - for decorative reasons - should be cleaned several times each year.

##### Cleaning instructions

Shake bottle well before use. Apply Eloxal Polish Cleaner thinly with a soft cloth and over a large surface. Various stains, as well as dark anodised elements should be evened out with polishing movements.



#### 4.7.3. Cleaning agent for powder-coated surfaces

Solvent containing, acidic and alkaline cleaners affect the surface of powder coating and must not be used just like scratching or scouring cleaning agents.

We recommend aroma-free cleaning petrol or isopropyl alcohol (IPA) for removing persistent, fatty, greasy dirt. These cleaning agents must only have short contact with the surface and be rinsed off with clear water.

#### 4.7.3.1 Conservation agent for powder coated surfaces

##### Powder Polish Cleaner

This cleaning and conservation agent is a care product on emulsion basis.

##### Application range

The Powder Polish Cleaning Conservation agent is suitable for newly fitted powder laquer surfaces after pre-cleaning and for diverse dirt on powder-coated aluminium parts which require several cleanings per year.

##### Cleaning instructions

Shake bottle well before use. Apply Eloxal Polish Cleaner thinly with a soft cloth and over a large surface. Slight stains, as well as dark anodised elements should be evened out with polishing movements. Powder coated surfaces that have already started chalking must first be cleaned with Powder Clean.



#### **4.8. Cleaning instructions for stainless steel**

Stainless steel is used in the building industry primarily where aesthetics and hygiene are the main focus.

As it cannot be avoided that a rust film or flash rust may deposit on the surface, this often leads to the erroneous assumption that stainless steel has rusted.

We recommend treating surfaces with visible stains or corrosion using standard stainless steel cleaners. These can be obtained in respective specialist shops.

#### **4.9. Care and maintenance of the I-tec ventilation system**

The ventilation system should be regularly checked and maintained. Free up machine from dirt and check clamping screws for tight fitting. Test the ventilation system with a test run. Maintenance and repair of parts inside the ventilation housing are to be carried out exclusively by authorised personnel. Opening of the ventilation housing which lies under the cover leads to loss of warranty and exclusion of liability.

Please use a soft, slightly damp cloth to clean the housing parts and the ventilation grid. Please do not use corrosive chemicals, aggressive cleaning solutions or solvents to avoid damages to the surface. Protect your ventilation system permanently from water and dirt.

#### **4.10. Special warning for timber/aluminium elements**

Natural timber always tends to adapt to its surrounding humidity. This characteristic remains the same throughout the entire life cycle, from the living tree to the processed timber element. Protect your windows especially during the construction period from excess construction humidity. This applies especially to winter construction sites, where large amounts of water occur due to plastering and screed works in closed buildings. Ensure sufficient ventilation during the construction period. Too high humidity over a longer time period can lead to swelling of timber profiles and cause severe damage on corner connections and surfaces.

## 5. COMFORT

Not only the room temperature and humidity in the air determine how comfortable and cosy a room appears.

The temperature difference between room air and surfaces enclosing the room, as well as the corresponding radiation asymmetries and air movements (room air turnover), are also related to this.

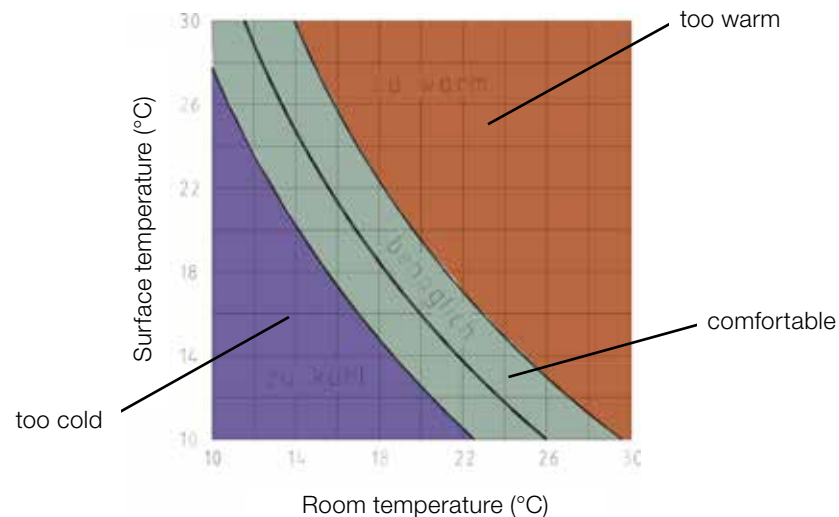

Example: If the wall surface has a temperature of 18° C and the room air temperature is 20° C , an average person will feel more comfortable than with a wall temperature of 15° C and an air temperature of 24° C. This means that the temperature difference between room air and enclosing surfaces should not exceed 2° C.

In rooms with relatively large temperature differences between walls and room air, the warm air cools down at the walls, sinks down to the floor, and results in a pool of cold air. This constant air movement results in the impression of a draught (room air turnover).

Therefore, good thermal insulation of the enclosing surfaces is important!

## 6. AIRING

The minimum oxygen demand for humans is approx. 1.8m<sup>3</sup>/h per person. In order to accommodate pollutants and odours, the amount of fresh air needed hygienically is 10 to 25m<sup>3</sup>/h per person.

The amount of air inflow necessary to get moisture out depends on the amount of occurring moisture, the indoor climate, the outdoor climate and the size of the room.

People in living and work spaces create water vapour. The occurring water vapour originates from the breath of the present people, evaporating from watering flowers, bathing, showering, cooking and similiar processes.

The amount of water vapour that may occur is demonstrated in the explanation below.

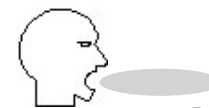

Breathing air:  
Daily 1-2 litres of water

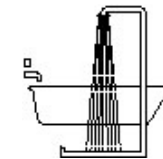

Bathing, washing,  
laundry, watering  
flowers: Daily up to 3  
litres of water in a 3  
person house hold

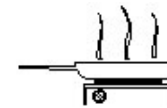

Cooking:  
Daily up to 2 litres of water  
in a 3 person household



The humidity rises  
further if laundry is hung  
up to dry in the room.

Therefore, a 3 person household accumulates approx. 180 litres of water per month; this is more than one bathtub full of water.

If the water cannot get outside sufficiently through airing, the humidity level in the air rises, which leads to condensation and can then lead to mould.

**Airing – but correctly!**

Internorm windows have very good thermal insulation characteristics and good impermeability. This protects you from bothersome draughts, cuts down on heating costs and keeps out disturbing noise. However, it also necessitates more conscious airing.

Correct airing is immensely important. It assures a constant oxygen supply for breathing air as well as carrying off pollutants which accumulate when aired insufficiently. Furthermore, with correct airing you can avoid condensation as well as the danger of mould developing.

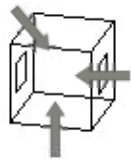
**Which airing options are there?**

Self-airing:  
“Airing“ with closed windows and doors due to permeability of the building shell.

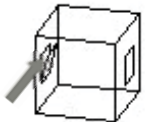

Constant airing:  
Constantly slightly opened windows due to gap ventilation or via tilt hardware.

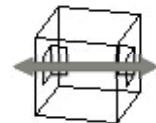

Maximum airing for a short time:  
Airing with fully open windows on opposite sides of a room.

It is recommended to carry out maximum airing for 5 minutes several times during the day.

This is most effective if windows on opposite sides of the room can be used for airing.

This maximum airing, several times a day, will ensure the desired air exchange and take out humidity without affecting the comfort. The room temperature will fall for a few minutes, but the “heat storage“ in walls, ceiling and floor will cool down only minimally in this short time. The fresh air will heat up again quickly, energy loss is minimal.

**What do I need to know?**

Air exchange through the gaps in closed windows is not sufficient for adequate reduction of humidity and hygienically necessary fresh air supply.

Depending on usage of the room and on the amount of produced humidity it is recommended to ensure air exchange through constant airing or maximum airing for a short time.

Transporting humidity into cooler rooms within the building should generally be avoided. If this is not possible, please take this into consideration when airing.

In rooms with open fireplaces (boilers, open fireplaces, oil stove, gas stove etc.) a constant supply of fresh air must be ensured.

Construction moisture leads to increased strain on the window profiles. In order to avoid surface damage or swelling of timber profiles, ensure sufficient airing!

Under extreme demands, e.g. in wet rooms, indoor swimming pools or rooms with chemicals, adapted heating and ventilation systems might become necessary.



## 7. WARRANTIES

**Internorm®**

These warranties only apply to surfaces listed in the Internorm aluminium colour fan, the Internorm RAL colour fan or the Internorm hirest colour fan.

---

10 year warranty against condensation between the panes of insulating glass. The guidelines applied for general visual assessment of mirrored insulating glass are those of the Federal Guild Association of the Glazing Trade Hadamar or Ö-Norm B3738.

Condensation on both sides of single glazing or on the room and/or weather exposed side of insulating glass are exempt. This condensation is due to physics and may occur under certain climatic conditions.

---

10 year warranty on the glue connection of glued Georgian/feature bars.

---

10 year warranty on the function of the material compound timber, thermal foam and aluminium profiles in HF 300 (EDITION), HV 340 (EDITION 4), HF 200 (VARION), HV 240 (VARION 4) and FUSION when adhering to the Internorm fitting and maintenance guidelines.

---

10 year warranty on the function of the glued connection and sealing of the insulating glass panes with window profiles in HF 300 (EDITION), HV 340 (EDITION 4), HF 200 (VARION), HV 240 (VARION 4) and FUSION when adhering to the Internorm fitting and maintenance guidelines.

---

10 year warranty where Products are supplied with marine grade aluminium finish. Validity of this warranty is at all times conditional upon compliance with all relevant requirements of this warranty document and, in addition, a maintenance programme that ensures that there is professional cleaning (with clean water) of the Product at intervals of six months obtained by the end customer who must then provide promptly to Internorm evidence in the form of a copy invoice demonstrating that the work has been completed – documentation to be provided by [recorded delivery] post to:

---

## 7. WARRANTIES

**Internorm®**

Unit D,  
Colindale Business Park  
2-10 Carlisle Road  
London NW9 0HW

The warranty is also conditional upon the end customer providing Internorm with access to the Property at which the Products are installed in order to verify compliance with the above requirements.

---

5 year warranty for PVD coated entrance door handles against corrosion, if no mechanical damage is apparent.

---

5 year warranty on weather resistance against unnatural colour changes or cracks in door filling surfaces. There is no warranty on the change of appearance of surfaces as a result of dirt.

---

3 year warranty on weather resistance against unnatural change of colour and cracks in surfaces of anodised or powder coated aluminium roller shutters, blinds and window shutter profiles. Minimum value for remaining gloss is the gloss level determined according to DIN EN ISO 2813, which is at least 30 % of the original value. Exempt from this warranty are corruptions due to environmental impacts such as fitting window and door elements close to the sea (salt in the atmosphere), close to roads with gritting or in an atmosphere polluted with heavy industry pollutants. There is no warranty on the change of appearance of surfaces as a result of dirt.

---

3 year warranty in the function of window and door hardware when adhering to the Internorm fitting and maintenance guidelines.

---

3 year warranty on weather resistance against unnatural change of colour and cracks in surfaces of UPVC roller shutter profiles. When assessing weather resistance, the change in colour, according to test systems corresponding to DIN EN 513, must not be greater than level 3 on the greyscale according to DIN EN 20105-A02. There is no warranty on the change of appearance of surfaces as a result of dirt.

---

## 7. WARRANTIES

Internorm provides services and warranty rights for the end customer as set out below:

The requirements set out in this document do not exclude or override the statutory rights that may be available to you against your original supplier and/or installer of the Products. Issues or concerns arising in relation to the operation or use of Products manufactured by Internorm should be taken up in the first instance with your Distributor or, if different, any installer of the Products. Internorm has committed to supporting its Distributors in dealing with issues arising associated with Internorm Products.

---

10 year warranty on weather resistance against unnatural change of colour and cracks in surfaces of white UPVC window and door profiles, except for mitre cracks. When assessing weather resistance, the change in colour, according to test system corresponding to DIN EN 513, must not be greater than level 3 on the greyscale according to DIN EN 20105-A02.

There is no warranty on the change of appearance of surfaces as a result of dirt.

---

10 year warranty on weather resistance against unnatural change of colour and cracks in surfaces of inside foil covered UPVC window and door profiles, except for mitre cracks. When assessing weather resistance, the change in colour, according to test system corresponding to DIN EN 513, must not be greater than level 4 on the greyscale according to ISO 105-A02. There is no warranty on the change of appearance of surfaces as a result of dirt.

---

10 year warranty on weather resistance against unnatural change of colour and cracks in surfaces of anodised or powder coated aluminium window and door profiles.

Minimum value for remaining gloss is the gloss level determined according to DIN EN ISO 2813, which is at least 30 % of the original value.

Exempt from this warranty are corrosions due to environmental impacts, such as fitting window and door elements close to the sea (salt in the atmosphere), close to roads with gritting or in an atmosphere polluted with heavy industry pollutants. There is no warranty on the change of appearance of surfaces as a result of dirt.

30 year provision warranty from construction year 1999

Furthermore, Internorm guarantees that Internorm products can be repaired by our specialists in such a way that their full functionality is guaranteed to exist or be retained over a time period of 30 years. However, this is subject to the construction (= frames and sashes) being undamaged. The 30 year period begins with the Internorm production date confirmation of which will be provided on request. The services or materials, labour time etc., necessary to retain functionality will be charged at respective current rates.

**7.1. General information**

Faults of any kind are to be brought to the attention of your Internorm Distributor immediately after receipt of the goods.

All delivered goods are to be examined thoroughly upon receipt. With faults of any kind, further processing is only possible after prior written communication with the Internorm Distributor subsequent to his explicit agreement to further fitting of these elements.

Warranties become invalid if surface damages have been caused with intent or out of negligence or by neglecting the necessary care. This applies especially to strongly stained or difficult to remove, persistent stains.

Warranties are also invalid if damage arises or functionality disturbances are due to fitting not completed by an Internorm Distributor or a party authorised by Internorm or an Internorm Distributor to carry out the installation or caused by other construction parts (e.g. roof, subsidence of construction parts).

Warranty claims are to be made immediately by the end customer, but at the latest by the deadline indicated in the warranty certificate. Delay may affect validity of the warranty. The claim has to be made with the Internorm Distributor that has delivered the items to the customer. If this is not possible, the warranty claim has to be made with the official Internorm office in the country in question. Warranty claims have to be made in writing.

It should be noted that the warranty for functionality of the product generally presupposes that the Internorm fitting and maintenance guidelines have been adhered to completely and especially assembly and fitting have been carried out completely professionally.

In sales and manufacturing contracts, the deadlines indicated in the warranty certificate generally begin with the date on which Internorm has delivered the products. If fitting is carried out by an authorised Internorm Distributor, the warranty period, as an exception, begins with the end of the fitting works (according to the records of the Internorm Distributor).

Driving times, material and labour costs as well as any other additional charges by Internorm are included in the warranty.

We may, however, charge our reasonable costs as a condition of continuing to deal with a warranty claim in the event that access to the relevant premises is denied or access is not practicable on health, safety or other appropriate grounds requiring rescheduling of attendance by Internorm's nominated personnel to another date.

The warranty is valid if Internorm is chosen for the complete or partial replacement of the product or for repair or improvement works. Further subsequent damages and costs, and especially fitting or removal costs (material and labour costs), and any additional costs are not subject to the warranty. For example writing applied by the customer to a glass element to be exchanged according to the warranty; also there is no compensation for the loss of income or earnings or inability to use the rooms included in the warranty works, etc.).

Warranty services are delivered free.

Items which have been discounted in price by reason of any specified manufacturing defects or irregularities do not benefit from warranties to the extent specified in the relevant product order form issued by the Distributor.

**7.2. Fitting advice**

All hardware versions are equipped with "fine adjustments". These fine adjustments are to be carried out as part of the fitting service provided by the fitting company. The Internorm fitting and adjustment guidelines are to be adhered to in each case, especially for self-fitting.

Any subsequent necessary adjustment works, maintenance or changes to the product must be charged.

Faults in fitting and any faulty functions resulting thereof are to be covered by the respective fitting company and are not part of Internorm warranties.

### 7.3 Technical limitations of the warranty

The warranty applies as long as the usual loads stated in common technical standards are not exceeded. If the product is used in an unusual way, no part of the warranty applies.

The above mentioned warranty services only refer to the respective single element in question. If two or more single elements are connected to form continuous window/door surfaces, a separate approval by Internorm is necessary. Apart from this, all warranties are rendered invalid, if the connection of single elements is not carried out professionally and does not comply with technical standards.

Surface damages caused by aggressive or scouring cleaning agents will invalidate the warranty. Internorm recommends regular cleaning with the Internorm care set. Particular attention must be paid to any special instructions relating to the care and maintenance of any individual product supplied. Any failure to follow special instructions may invalidate the warranty.

Surface changes caused by chemical reactions (e.g. zinc particles, leachates from the facade [cement asbestos or other] and cement asbestos windowsills) on white UPVC profiles and on powder coated or anodised surfaces are exempt from the warranty.

There is no warranty on the change of appearance of surfaces as a result of dirt.

Different colour changes in different elements caused by the fitting location between elements exposed to weather (e.g. south-facing) and elements in protected position (e.g. north-facing) are exempt from warranty.

For timber elements it is explicitly indicated that aggressive cleaning agents (containing ammonium chloride, alcohol, as well as acidic or scouring cleaning agents) will damage the timber surface and may invalidate the warranty. Timber elements are to be regularly checked for damages (hail damage, natural cracks in timber, scratches etc.) and possibly mended for short term according to the Internorm maintenance guidelines. Any failure to do so may invalidate the Warranty.

The surface warranty does not apply to fitting material.

Deposits of dust, pollen, dirt etc. on gaskets, profiles and glass surfaces in connection with humidity cause formation of microorganisms and therefore mould. This is a natural process and not lack of quality. Formation of mould, therefore, is excluded from warranties and liabilities.

Condensation on glass surfaces:

Under certain conditions water condensation may occur on the outer glass surface of insulating glass on the inside or the weather-exposed side.

On insulating glass with especially high thermal insulation temporary condensation may also occur on the weather-exposed side, if the outside humidity (relative air humidity outside) is very high and the air temperature is higher than the temperature of the pane surface. With especially extreme temperature differences, icing over may also occur. This can be solved by shading the window and door elements (e.g. with roller shutters, projecting roofs etc.).

Condensation on the glass in composite windows is exempt from the warranty as, for physical reasons, under certain climatic conditions, condensation might form in the space between the panes (where the optimum sun protection is).

The wetting properties of glass surfaces on the outside of insulating glass may be differing due to e.g. marks from rollers, fingers, labels, paper structure, vacuum suckers, sealing remains, smoothing agents, sliding agents or environmental impact. On wet surfaces due to rain, dew or cleaning water, differing wettability may be observed. Therefore, these marks do not represent defects.

